

# Clamping modules type SMD 2 and NSMD 2

for actuating hydraulic clamping devices

Flow  $Q_{\max} = 25 \text{ lpm}$   
Operation pressure  $p_{\max} = 120 \text{ bar}$

- One valve for the control of functions, clamping pressure and monitoring of the clamping pressure
- One adjustment element for both clamping pressure and monitoring of the clamping pressure (either manual or electro-proportional)
- The clamping pressure is safely controlled even with low clamping pressure
- The pressure is controlled directly at the consumer port
- A special protective circuit supervises the switching position of the directional valve
- The pressure reduction applies either for both consumer ports (A and B) or for (A) only
- Connection hole pattern DIN 24340-A6 with type NSMD 2

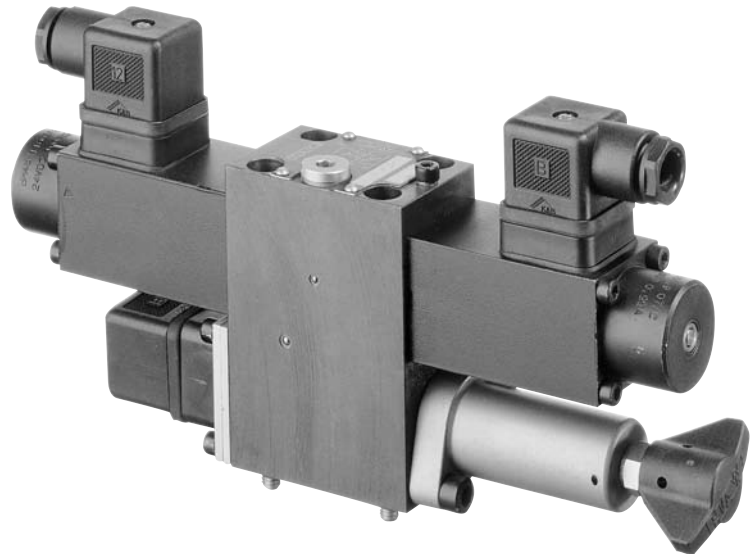

## 1. General information

This complete control unit is designed as a manifold mounting valve which is suitable for the actuation of hydraulic clamping devices, such as draw-in collets (hollow or massive) at CNC-lathes. A solenoid actuated 4/3- or 4/2-way directional valve and a 3-way pressure reducing valve with integrated pressure switch are housed in a common body.

The 3-way pressure reducing valve reduces the existing pressure in gallery P (primary side) down to the clamping pressure (secondary side). The especially shaped spool of the directional valve creates a control passage to the pressure reducing valve according to the respective switching position. The micro switch integrated into the pressure reducing valve (monitoring of the clamping pressure) triggers a signal at a certain difference to the set pressure. When the setting of the pressure reducing valve is altered, the pressure switch will follow automatically still maintaining this predefined difference. This feature is unique and makes any readjustment of the pressure switch unnecessary.

The clamping module was designed in such a way that the pressure switch gives always a clear acknowledgment signal or supervisory signal over the complete adjustment range. This is accomplished by a switch-over of the pressure switch mode independent of the clamping pressure setting. In the lower adjustment range both the clamping pressure and the flow are supervised. This makes sure that the (clamping pressure acknowledgment) signal, triggered by the pressure switch, takes place only after the draw-in collet is in its final position and the clamping pressure is reached. Therefore the clamping module can supervise the complete clamping procedure (start and end), detect any pressure loss due to a defect (e.g. line rupture, pump malfunction). The curves in sect. 4.1 illustrate the relations of the pressure where a signal is triggered, the flow and the clamping pressure

Several flow patterns (4/3- and 4/2-way) are available for this directional valve, see sect. 3.1 and 3.2. The pressure reduction including pressure monitoring can be opted for consumer ports A and B or for port A only. The internal connection of the control gallery and the respective consumer port is provided only shortly before the final position of the spool is achieved. Before this the control gallery is connected to the reflow gallery. This makes sure that both, clamping pressure acknowledgment and pressure monitoring, take place only if the directional valve has achieved the selected switching position.

**Attention:** Take into account the safety regulations in section 6!

- Selection criteria:
- Flow patterns (section 3.1)
  - Clamping pressure range (section 2 and page 7)
  - Type of pressure adjustment (section 3.2)
  - Possibilities for influencing the consumer velocity (avail. orifices, see sect. 2 and additional functions, see sect. 3.3)

## 2. Type coding, over view

Order example: **SMD 2 K / E / B 2 - G 24**  
**NSMD 2 D1 60/ G 3 R K / B 2,5 - G 24**

Nom. voltage of the actuation solenoids (for directional spool valves, see also D 7451)

**G 12** = 12V DC

**G 24** = 24V DC

**X 24** = 24V DC, no plug

Orifice in gallery P

(flow limitation, being required if the system is fed via an accumulator)

no coding = no orifice

**B 1** = Ø 1

**B 1,5** = Ø 1.5

**B 2** = Ø 2.0

**B 2,5** = Ø 2.5

**B 3** = Ø 3.0

Pressure switch

no coding = No pressure switch

**K** = with tracked pressure switch

Means of adjustment for the clamping pressure (also see table 3a and 3b in sect. 3.2)

manual: no coding = Slotted screw + nut

**D** = Wing screw + nut

**R** = Wing screw + wing nut

**V** = Turn knob (self-locking)

**L** = Turn knob (lockable)

electro-proportional:

**P** = Proportional actuation without function monitoring

**Q** = Proportional actuation with function monitoring

Min. actuation flow (clamping - undoing)

no coding = Standard (2-4 lpm, see characteristics page 7)

**3** = 3-5 lpm

**4** = 4-6 lpm

Clamping pressure range

**G** = 5 ... 50 bar

**E** = 8 ... 80 bar

Additional functions (see section 3.3)

no coding = Standard

**66, 60** = Can be throttled in switching position (both sides, single-sided)

**2062** = Rapid traverse and creep speed in both directions

**206, 307** = Rapid traverse and creep speed in one direction only

Flow pattern (see table 2, section 3.1)

**B, W, K** = 4/2-way (pressure monitoring for both sides)

**B1, W1, K1** = 4/2-way (pressure monitoring in port A)

**D, E, G** = 4/3-way (pressure monitoring for both sides)

**D1, E1, G1** = 4/3-Way (pressure monitoring in port A)

Basic type (see table 1, section 3.1)

**SMD 2** = Standard version with HAWE hole pattern (superior flow characteristic)

**NSMD 2** = Version with hole pattern conforming DIN 24340-A6

For additional versions, see section 7

### 3. Available versions, main data

#### 3.1 Selection tables

Order examples: **SMD 2 G / E** - G 24  
**NSMD 2 K / G R K / B 2,5** - G 24

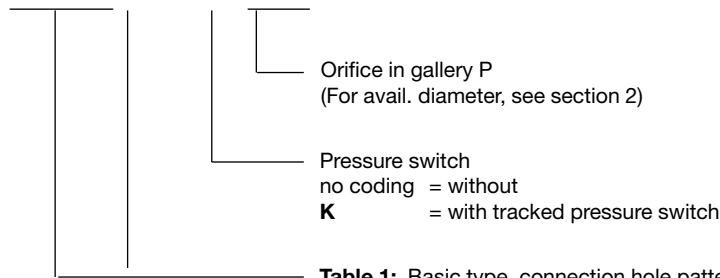

**Table 1:** Basic type, connection hole pattern

Coding (type and size)	Connection hole pattern (manifold mounting) <sup>1)</sup>	Flow Q <sub>max</sub>	Operation pressure p <sub>max</sub>
<b>SMD 2</b>	standard with HAWE hole pattern (superior flow characteristic)	25 l/min	120 bar
<b>NSMD 2</b>	hole pattern conf. DIN 24340-A		

<sup>1)</sup> For nom. size, see dimensional drawings in sect. 5

**Table 2:** Flow pattern symbols

Suited for type	Coding and flow pattern									
	4/3-way			4/2-way						
SMD 2	<b>D</b>		<b>D1</b>		<b>B</b>		<b>W</b>		<b>K</b>	
	<b>E</b>		<b>E1</b>		<b>B1</b>		<b>W1</b>		<b>K1</b>	
	<b>G</b>		<b>G1</b>		<b>B1</b>		<b>W1</b>		<b>K1</b>	
NSMD 2	<b>D</b>		<b>D1</b>		<b>B</b>		<b>W</b>		<b>K</b>	
	<b>E</b>		<b>E1</b>		<b>B1</b>		<b>W1</b>		<b>K1</b>	
	<b>G</b>		<b>G1</b>		<b>B1</b>		<b>W1</b>		<b>K1</b>	

The symbols below must be completed with the flow pattern symbols above. Illustrations below are with pressure switch (coding **K**).

4/3-way:  
Coding D, E, G  
and D1, E1, G1

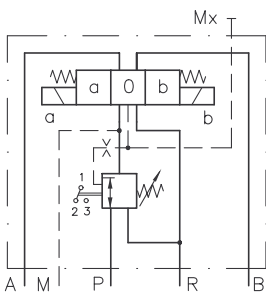

4/2-way:  
Coding B and B1

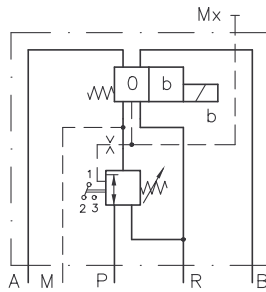

Coding W and W1

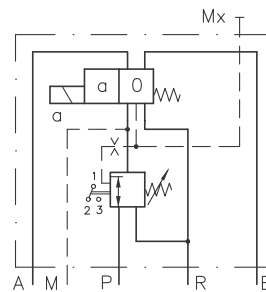

Coding K and K1

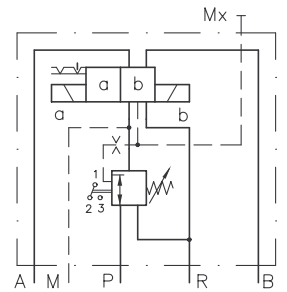

Version without pressure switch

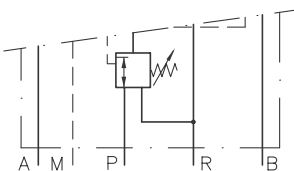

Version with throttle (coding **B...**)  
and pressure switch (coding **K**)

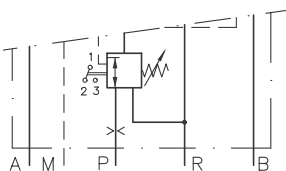

### 3.2 Actuators for adjustment of the clamping pressure

Order example NSMD 2 K / G **R** K / B 2,5 - G 24  
 NSMD 2 K / G **P** K / B 2,5 - G 24

**Table 3a:** Manually adjustable adjustment device

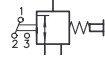
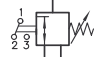
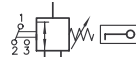
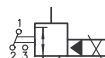
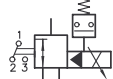
Coding	Description (for illustrations, see unit dimensions sect. 5)	Flow pattern symbols
no coding	Slotted screw + nut	
<b>D</b>	Wing screw + nut	
<b>R</b>	Wing screw + wing nut	
<b>V</b>	Turn knob (self-locking)	
<b>L</b>	Turn knob (lockable) The adjustment knob can only be manipulated, if the key is plugged in. The turn knob is disengaged when the key is removed, disabling (arbitrary) alternation of the pressure setting.	
<b>P</b>	electro-proportional adjustment	
<b>Q</b>	electro-proportional adjustment with additional function supervising	

**Table 3b:** Electro-proportional actuation

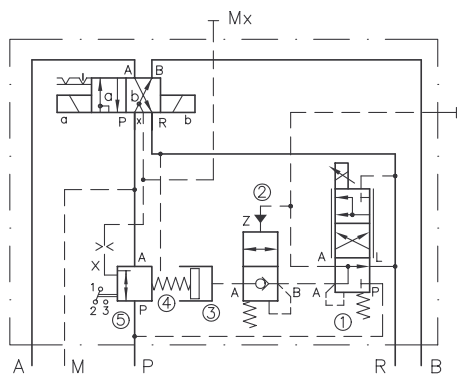
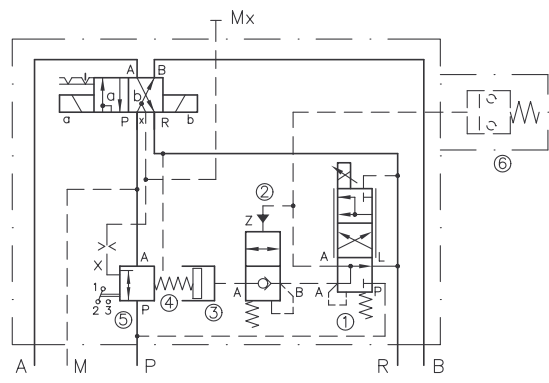
Coding, description, detailed flow pattern symbol	Functional description
<p><b>P</b> Without function monitoring</p> 	<p>The clamping module type (N) SMD 2 can be adjusted manually and electro-proportional by means of a directly mounted ancillary block. Thus enabling electro-proportional control of the pressure at ports A or B, within the respective pressure range. The system can therefore be operated either from the control panel of the machine or directly from an external control system such as SPS, CNC, PC. An additional safety function maintains the pressure setting even if the power supply fails.</p> <p>The electro-proportional ancillary block consists of a piloting pressure reducing valve ①, a check valve ②, a control piston ③ applying force on the spring ④ of the 2-way pressure reducing ⑤ valve in the clamping module.</p> <p>The piloting pressure reducing valve generates a proportional control pressure which is lower than the one apparent in the pressure gallery. This control pressure acts on the piston, pre-loading a spring which loads the control spool of the 2-way pressure reducing valve.</p>
<p><b>Q</b> With function monitoring</p> 	<p><b>Safety function:</b> The additional 3/2-way function of the piloting pressure reducing valve has to open up the check valve, enabling free flow from the pressure reducing valve to the control piston, before the proportional pressure regulation actually takes place. In case of a power failure (e.g. failure of the electronics or cable disruption) the piston of the piloting pressure reducing valve will jump back in its initial position, the check valve will close and lock in the pressure apparent at the control piston.</p> <p>The clamping pressure will drop only approx. 4% if this should happen.</p> <p><b>Function monitoring:</b> An additional pressure switch in the control line to the check valve supervises the function of the complete control electronics and the piloting pressure reducing valve.</p> <p><b>Electrical control:</b> A proportional amplifier is necessary for the control e.g. type EV1M2 (D 7831/1) or EV1G1 (D 7837).</p>

### 3.3 Additional functions

Order examples 1: SMD 2 G1 **66** / E V K - G 24  
 NSMD 2 D1 **60** / G R K / B 2,5 - G 24

**Table 4:** Clamping module with throttle 1)  
 (Limitation of the max. velocity)

Pressure reducing function in the switching position	a and b	a and b	b	b	Complete flow pattern symbol (Example G 166)
Throttle in the switching positions	a and b	b	a and b	b	
Coding	<b>66</b>	<b>60</b>	<b>166</b>	<b>160</b>	
Spool flow pattern (here for type NSMD, analogous available for type SMD)	G..				
	E..				
	D..				

Order examples 2: SMD 2 **G 2062** / G R K / B 2,5 - G 24  
 NSMD 2 **D 307** / E R K / B 2,0 - G 24

**Table 5:** Clamping module section - tailstock 1)  
 (Selection of the currently available types, further variants on inquiry)

Coding	Use and description	Flow pattern symbols 2)
<b>G 2062</b> <b>D 2062</b> <b>E 2062</b>	Rapid traverse and creep speed in both directions <ul style="list-style-type: none"> <li>Approach tailstock in rapid traverse                              Actuate solenoid "a"                              Orifice <math>\varnothing 2.5</math> in the gallery P                              No function of pressure reducing valve and pressure switch</li> <li>Approach tailstock in creep speed                              Actuate solenoid "c"                              Orifice <math>\varnothing 0.6</math> (<math>2 \times \varnothing 0.4</math>) P <math>\rightarrow</math> A                              Full function of pressure reducing valve and pressure switch</li> <li>Retract tailstock in rapid traverse                              Actuate solenoid "b"                              Orifice <math>\varnothing 2.5</math> in the gallery P, throttle <math>\varnothing 2</math> P <math>\rightarrow</math> B                              No function of pressure reducing valve and pressure switch</li> <li>Retract tailstock in creep speed                              Actuate solenoid "d"                              Orifice <math>\varnothing 0.6</math> (<math>2 \times \varnothing 0.4</math>) P <math>\rightarrow</math> B                              No function of pressure reducing valve and pressure switch</li> </ul>	Type G (D, E) 2062
	Rapid traverse and creep speed (tailstock motion) one way only with simultaneous limitation the rapid traverse (throttling). Rapid traverse in opposite direction (retracting the tailstock) <ul style="list-style-type: none"> <li>Approach tailstock in rapid traverse                              Actuate solenoid "a"                              Orifice <math>\varnothing 2</math> in the gallery P                              Version .207 = Fixed rapid traverse speed; no function of pressure reducing valve and pressure switch                              Version .307 = Speed limitation possible by means of an orifice (P <math>\rightarrow</math> A); full function of pressure reducing valve and pressure switch</li> <li>Approach tailstock in creep speed                              Actuate solenoid "c"                              Orifice <math>\varnothing 0.7</math> (<math>2 \times \varnothing 0.5</math>) P <math>\rightarrow</math> A                              Full function of pressure reducing valve and pressure switch</li> <li>Retract tailstock in rapid traverse                              Actuate solenoid "b"                              Orifice <math>\varnothing 2</math> in gallery P                              No function of pressure reducing valve and pressure switch</li> </ul>	Type G (D, E) 207 G (D, E) 307

- 1) The pick-up of the load signal is not influenced by the orifice / throttle as it is located directly at the consumer port.
- 2) Illustration for type SMD..., analogous available for type NSMD..
- 3) The orifice diameter can be selected according to the required consumer speed (on request)

## 4. Further parameters

### 4.1 General and hydraulic

Type coding	SMD 2 or NSMD 2 see section 3
Design	Clamping module (combination of directional spool valve, pressure reducing valve a. tracked pressure switch)
Installed position	any
Ports	P = pressure inlet R = reflow A, B = consumers M = for pressure gauge (on the mounting area) Mx = for pressure gauge (top side of the valve)
Port size	P, R, A, B and M = NW see hole patterns section 5 Mx = G 1/8

Surface termination All surfaces corrosion inhibiting gas nitrided

Mass (weight) approx. kg	Basic type	Spool coding	Actuation	
			manual	electro-proportional P and Q
	SMD 2	D.. to K1..	2.7	3.8
	NSMD 2	B(1) and W(1)	2.2	3.3
	Version ..2062		+ 1.1 kg	
	Version ..207, ..307		+ 0.6 kg	

Operation pressure P = max. 120 bar  
A, B, M, Mx = acc. to the pressure range  
R = 20 bar

Pressure fluid Hydraulic fluid (DIN 51524 table 1 to 3); ISO VG 10 to 68 (DIN 51519)  
Viscosity range: min. 4; max. 1500 mm<sup>2</sup>/s  
Optimal operation range: 10...500 mm<sup>2</sup>/s  
Also suitable are biologically degradable pressure fluids of the type HEPG (Polyalkylenglycol) and HEES (synth. Ester) at operation temperatures up to +70°C.

Temperatures Ambient: -40...+60°C  
Oil: -25...+80°C, (Note: Viscosity range!)  
Start temperature down to -40°C are allowable (Note: Viscosity range!), as long as the operation temperature during consequent running is at least 20K (Kelvin) higher.  
Biodegradable pressure fluids: Pay attention to manufacturer's information. With regard to the compatibility with sealing materials do not exceed +70°C.

Δp-Q-curve

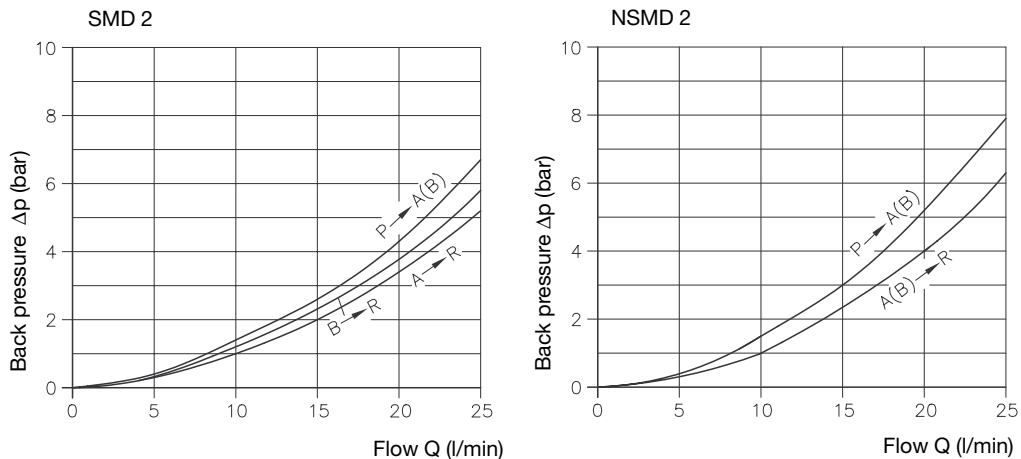

Oil viscosity during measurement approx. 60 mm<sup>2</sup>/s

Clamping pressure / trigger pressure - curve  
(Pressure ranges E and G)

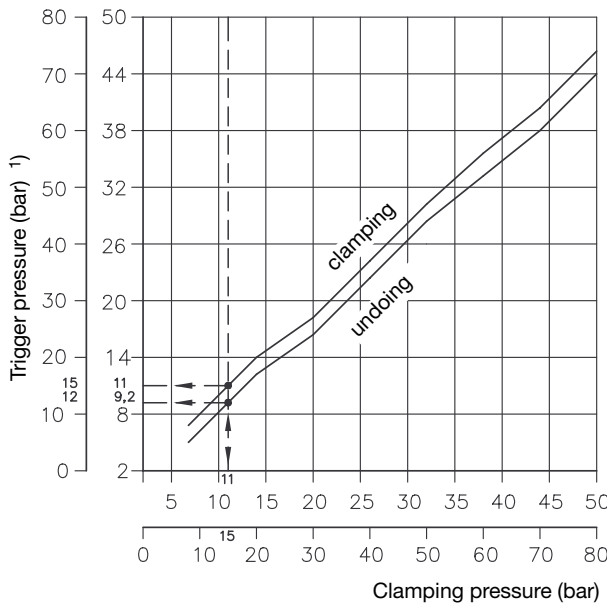

Clamping pressure / trigger flow - curve  
(Pressure ranges E and G) - standard version

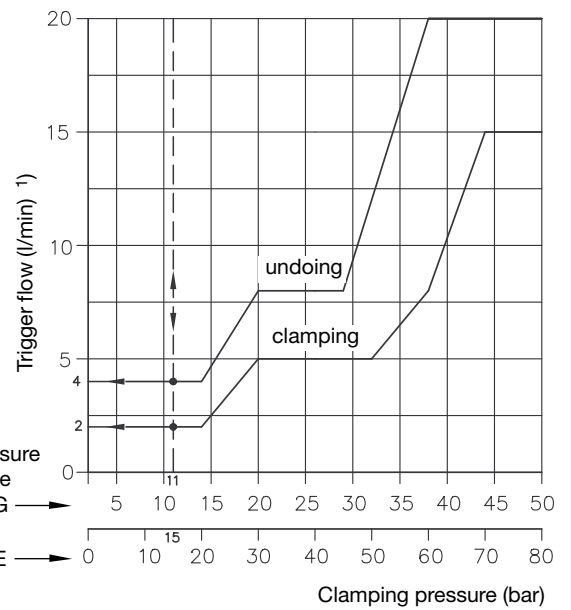

Trigger pressure is the pressure at which the pressure switch triggers a signal at a definite clamping pressure.

Trigger flow is the flow which must flow through the valve (at a definite clamping pressure) enabling the pressure switch to trigger a signal.

Attention: The maximum leakage must be smaller than the flow necessary for "undoing".  
It is possible to recalibrate the clamping pressure / trigger flow - curve. For setting (by HAWE) and order coding, see sect. 2 "min. trigger flow").

**Example:**

A clamping pressure of 11 bar will result in a trigger pressure of  $\leq 11$  bar during clamping whereas the resulting trigger pressure will be  $\geq 9.2$  bar during undoing. The trigger flow is  $\geq 2$  lpm during clamping and  $\leq 4$  lpm during undoing. This means that the contact switch will trigger a signal, if either if the work piece is clamped and the clamping pressure is achieved (no more cylinder movement) or the flow drops below 2 lpm. A signal will be triggered during undoing if a flow of 4 lpm is exceeded or the clamping pressure drops below 9.2 bar.

Pressure range of G = 5 ... 50 bar

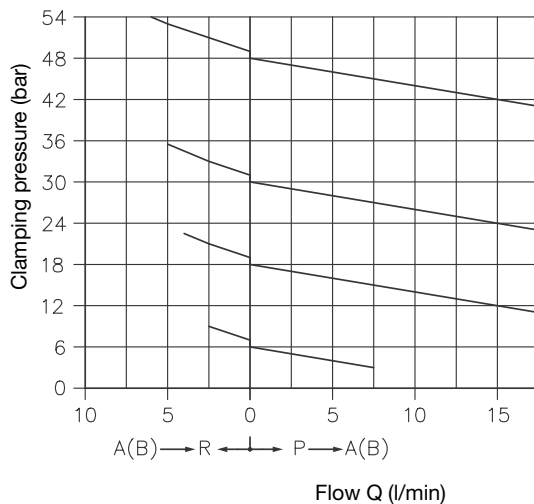

Pressure range of E = 8 ... 80 bar

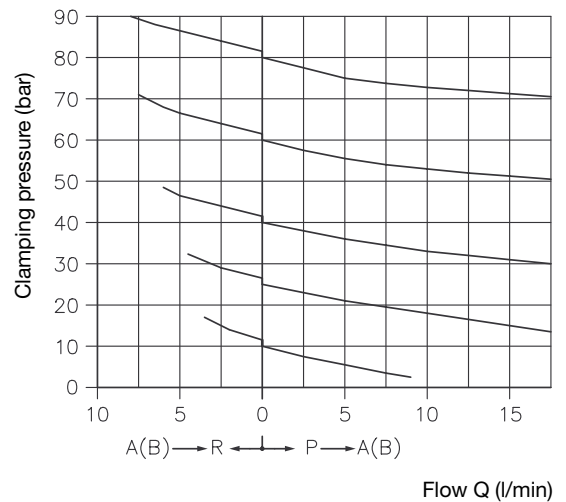

Oil viscosity during measurement approx. 60 mm<sup>2</sup>/s

- 1) System pressure when adjusting the pressure range G  $p_{pu} = 70$  bar
- pressure range E  $p_{pu} = 100$  bar

The trigger flow changes insignificantly in dependence of the system pressure.

### 4.2 Electrical data

Directional spool valve and pressure switch:

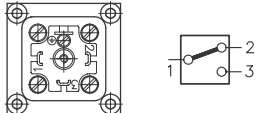
Solenoid	conforming VDE 0580			
Nom. voltage $U_N$	12V DC	24V DC	110V AC	230V AC
Nominal power $P_N$ (W)	24.4	24.4	24.4	24.4
Relative duty cycle	100% ED (duty cycle) at ambient temperature < 40°C			
Device connector	DIN 43650 A Pg9			
Protection class DIN 40050	Solenoid IP 65, plug IP 65 (plug fitted)			
Pressure switch	Co. Burgess type F1T8-ZBK			
Mechanical service life	10 <sup>7</sup> cycles			
Resistor load	up to 30V DC 5A up to 15V DC 10A			
Inductive load	up to 30V DC 3A up to 15V DC 10A			
Circuitry of the pressure switch	Idle position 1-2			
	Switching position 1-3			

electro-proportional control:

Solenoid	conforming VDE 0580	
Nom. voltage $U_N$	12V DC	24V DC
Coil resistance $R_{20}$ ( $\Omega$ )	6	24
Current, cold $I_{20}$ (A)	2.0	1.0
Nom. current $I_N$ (A)	1.26	0.63
Power, cold $P_{20}$ (W)	24	24
Nominal power $P_N$ (W)	9.5	9.5
Relative duty cycle	100% ED	
Electrical connection	DIN 43650 B (industrial standard)	
Protection class DIN 40050	IP 65	
Nec. dither frequency	100 ... 150 Hz	
Control via electronic intensifier	e.g. type: EV1G1-12/24 (D 7837) type: EV1M1-12/24 (D 7831/1)	

Adjustment instructions for min. and max. current:

Min. current:	The solenoid current should be set via the $I_{min}$ - potentiometer in such a way, that the requested min. pressure $p_{min} \geq 5$ bar (system pressure 5 ... 50 bar) or $p_{min} \geq 10$ bar (system pressure 10 ... 80 bar) is achieved.
Max. current:	$I_{max}$ must not exceed the nom. current $I_N$ of the solenoid.

Function monitoring:

Pressure switch	Co. Suco type: 0166 41503 1 059
Pressure setting (bar)	30
Pressure resistance (bar)	up to 300
Switch	NO-contact
switching performance (VA)	100
max. current (V)	42
Protection class	IP 65; pins IP 00
Switching frequency	200 / min
Mechanical service life	10 <sup>6</sup> cycles
Diaphragm material	NBR

Consumer pressure / solenoid current - curve

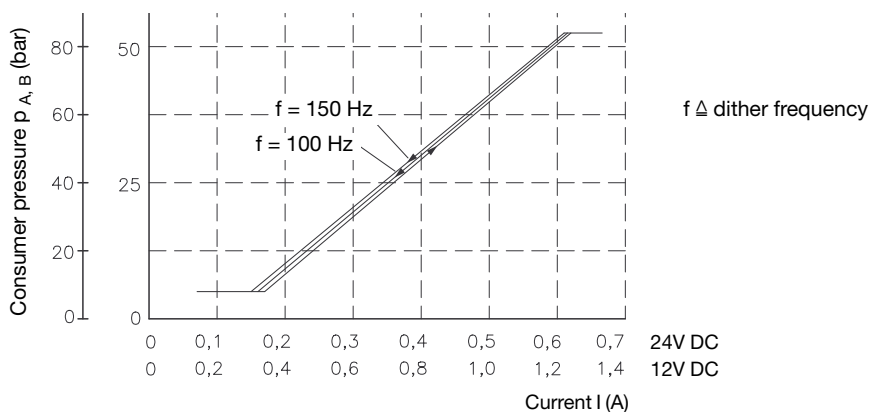



## 5. Unit dimensions

All dimensions in mm, subject to change without notice!

### 5.1 Type SMD 2

Coding **D, D1, E, E1, G, G1, K, K1**

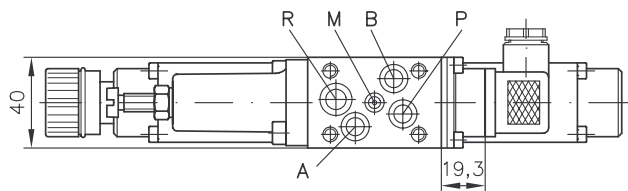

Port seals; O-rings NBR 90 Sh:  
 A, B, P = 9.25x1.78 There is a seal  
 R = 10.82x1.78 kit (DS 7787-11)  
 M = 5.28x1.78 available!

Cable gland Pg 9, Plug may be rotated 4 x 90°

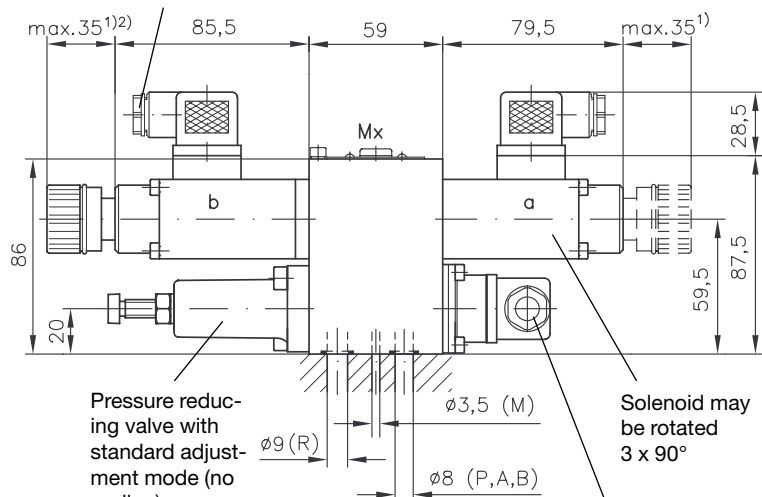

Pressure reducing valve with standard adjustment mode (no coding)

For coding D to L, see below!

Port for pressure gauge Mx = G 1/8

Solenoid may be rotated 3 x 90°

Pressure switch, coding K (Plug may be rotated 3 x 90°). See also notes for assembly on page 10!

#### Differing adjustment modes for the pressure reducing valve

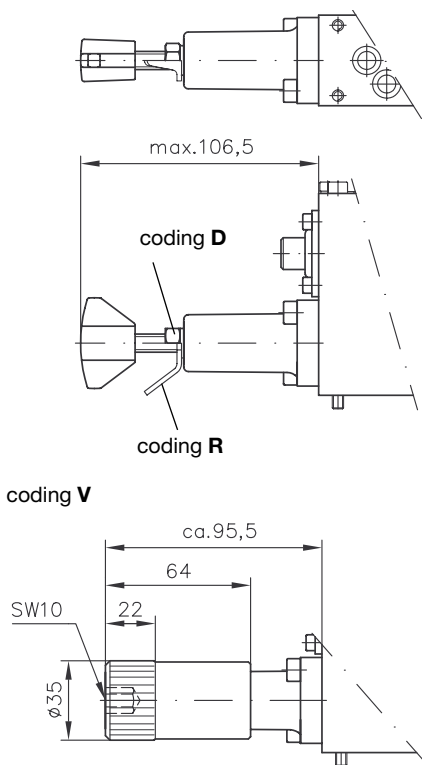

Coding **B, B1, W, W1**

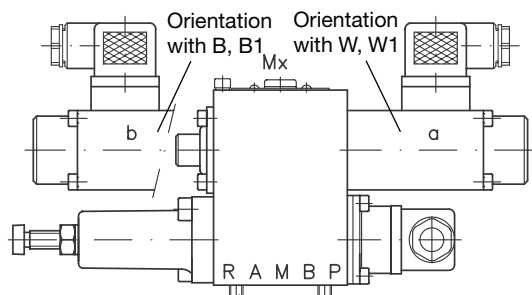
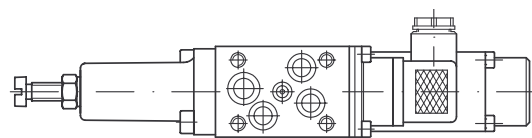

4 socket head screws ISO 4762 M6x55-8.8-A2K, torque 8 Nm

#### Required hole pattern of the manifold

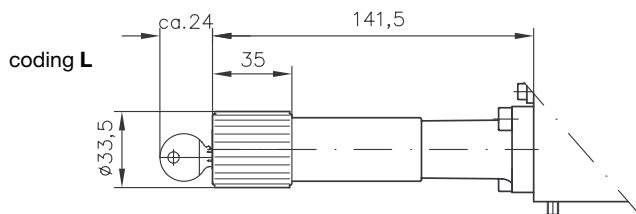
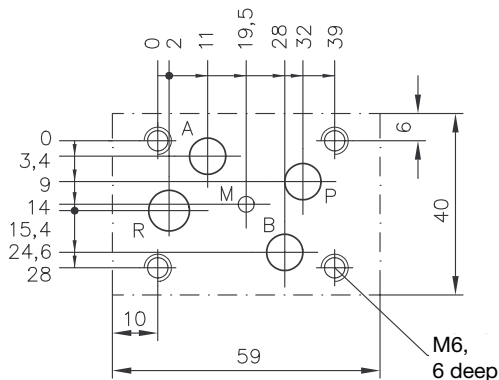

electro-proportion control coding **P** and **Q**

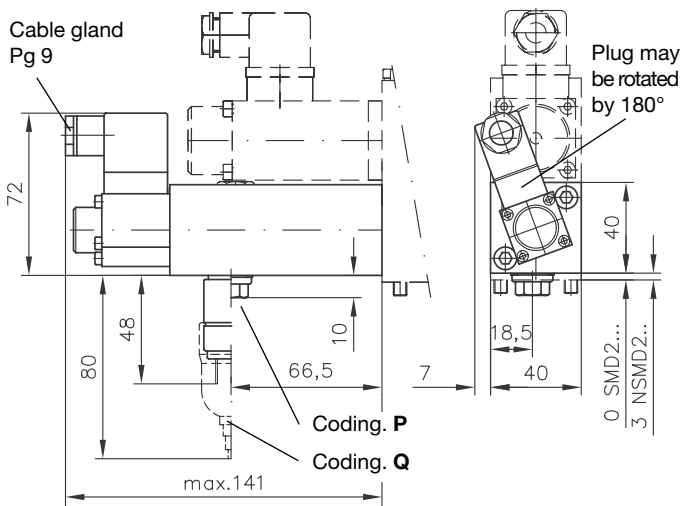

1) additionally with type ..66 or ..166 (sect. 3.3 table 4)

2) additionally with type ..60 or ..160 (sect. 3.3 table 4)

## 5.2 Type NSMD 2

Coding **D, D1, E, E1, G, G1, K, K1**

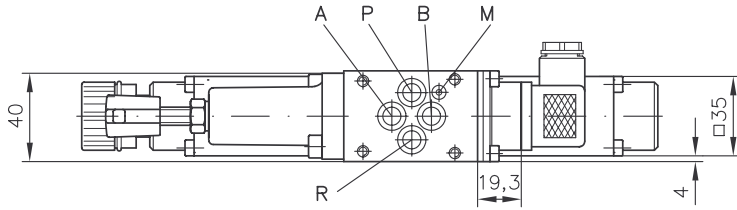

Port seals; O-rings NBR 90 Sh:  
 P, R, A, B = 9.25x1.78  
 M = 2.90x1.78

There is a seal kit (DS 7787-12) available !

Cable gland Pg 9, Plug may be rotated 4 x 90°

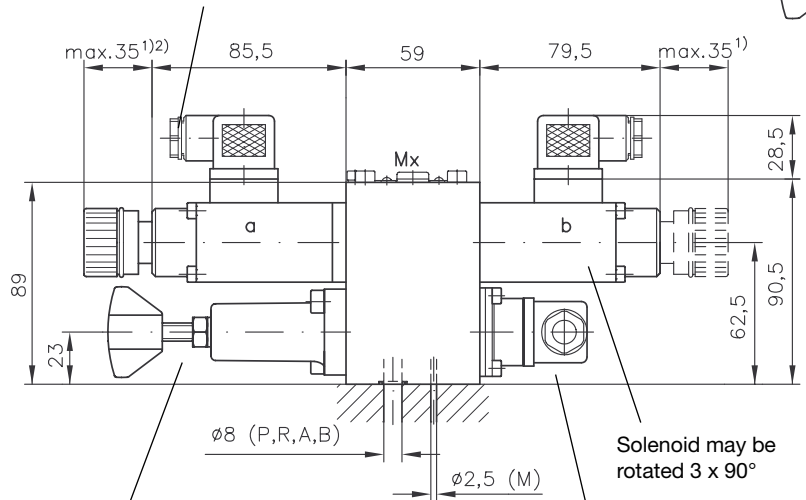

Pressure reducing valve, here with adjustment mode D. For other adjustment modes, see type SMD 2 on page 9.

Pressure switch, coding K (Plug may be rotated 3 x 90°).

Port for pressure gauge Mx = G 1/8

### Required hole pattern of the manifold

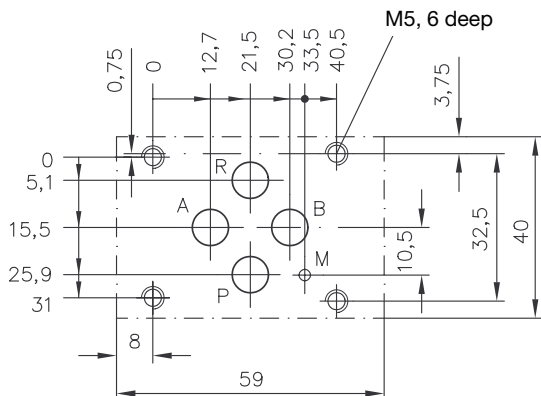

Coding **B, B1**

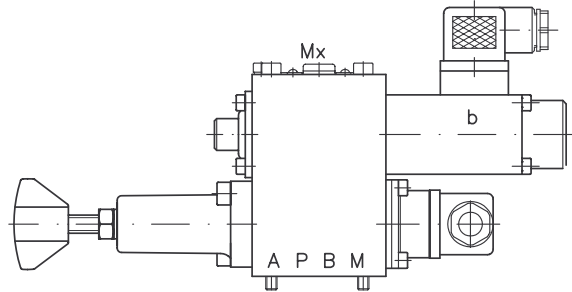
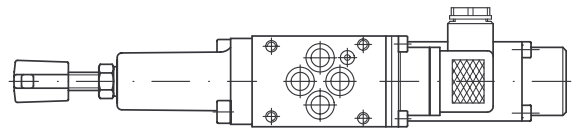

Coding **W, W1**

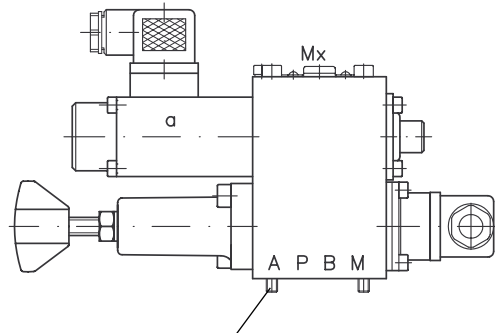
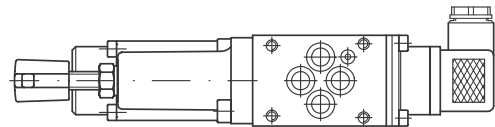

4 socket head screws  
 ISO 4762 M5x95-12.9 galvanized  
 torque 6 Nm

### Installation of the pressure switch

The plug is provided with a rubber seal, tightening the screw (thread M3) with a torque of 25...30 Nm ensures proper sealing.

Procedure if no torque wrench is handy: Screw in the screw until the plug contacts the surface and turn the screw 1.5 turns more.

**Attention:** Overtightening of the screw may cause mistriggering of the contact switch!

1) additionally with type ..66 or ..166 (sect. 3.3 table 4)

2) additionally with type ..60 or ..160 (sect. 3.3 table 4)

### 5.3 Clamping module sections for the tailstock

Type SMD 2 G2062 / ...

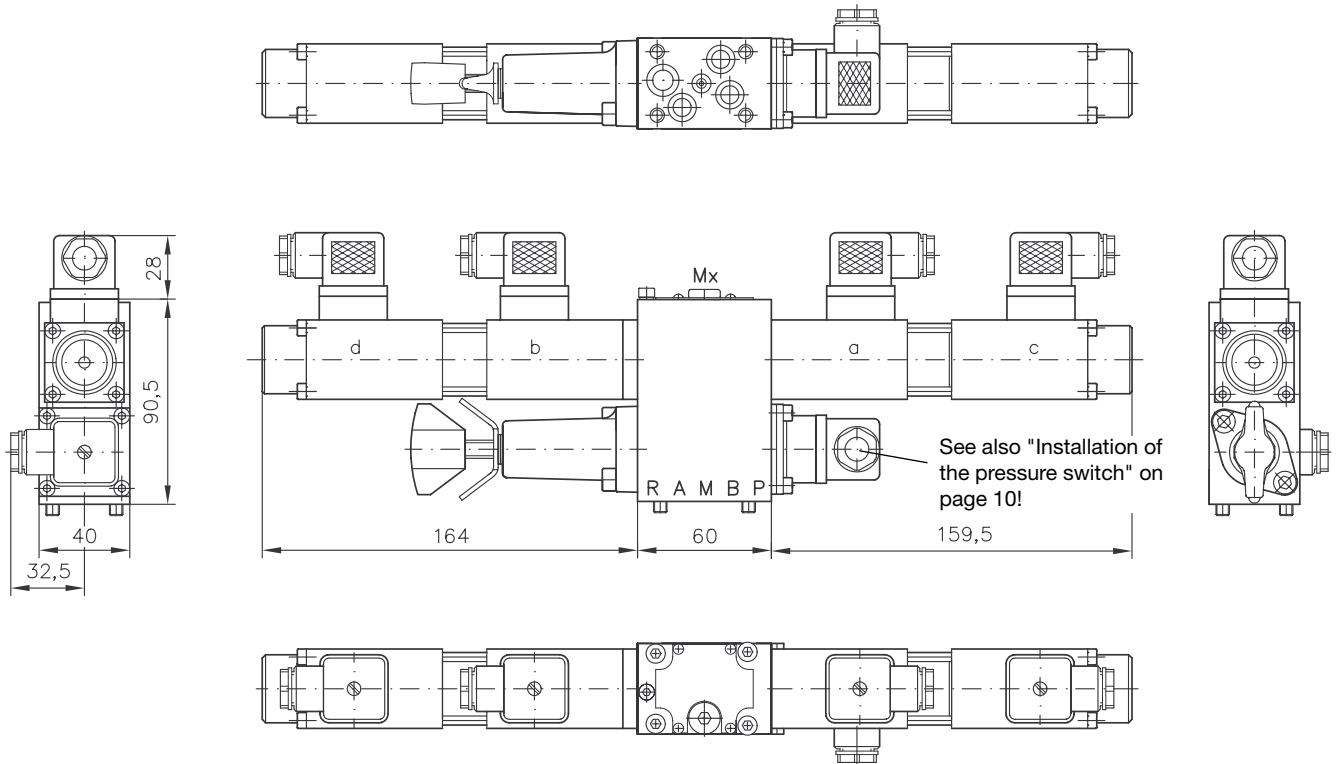

For missing dimensions see sect. 5.1 !

Type **SMD 2 .207 / ...**  
**SMD 2 .307 / ...**

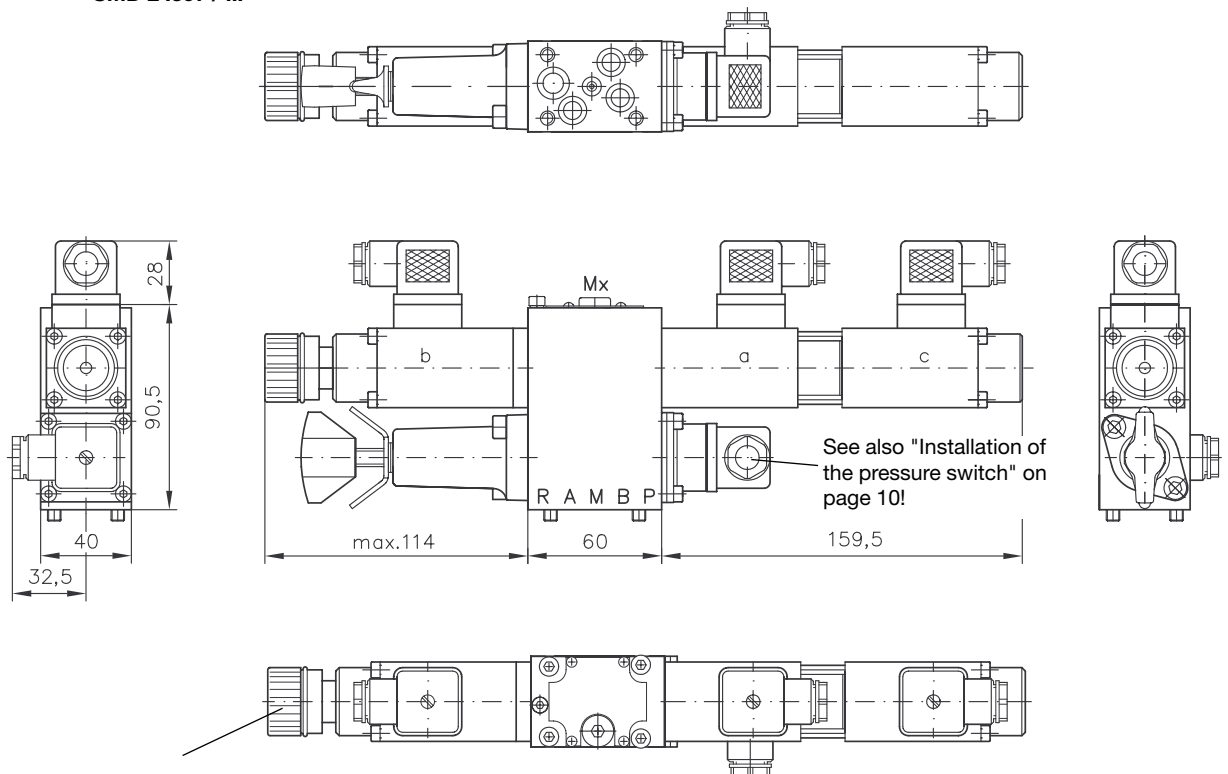

Velocity limitation for  
" Approach tailstock in rapid traverse "  
(throttle P → A),  
no actuation with version .207/..

For missing dimensions see sect. 5.1 !

## 6. Notes for the safety

The following notes for the safety should be observed when doing the layout for the machinery or the control system as well as the later use of it. They should be added to the corresponding documentation also, if necessary.

- Operator protection classification:  
 Category 2 (conforming DIN EN 954-1) under the prerequisite of a cyclical supervision (testing) of the micro switch installed in the pressure switch. This can take place e.g. at every operation of the directional valve.  
 The following notes are basis for this statement:  
 The micro switch incorporated in the pressure switch is used as a "switch for the operator protection". This usually takes a re-lays lift off system (according to EN 60947-5-1: 1991, sect. 3)  
 The utilized micro switch does not fulfill these requirements (like a switch conforming DIN VDE 0630).  
 Nevertheless the "Berufsgenossenschaftlichen Instituts für Arbeitssicherheit Fachbereich 5, Maschinenschutz/Steuerungstechnik" (official German approval institute for operator safety) specifies in a letter dated 25.09.97, that a comparable safety can be achieved with such a "less reliable" device (micro switch) by means of cyclical supervision.
- Function safety of the pressure switch:  
 Correct grounding of the valve is required (operator safety)  
 (The micro switch won't trigger a signal no matter if it fails or if it detects "No clamping pressure")
- Travel dependent stroke control for the collet:  
 A travel dependent stroke control (e.g. by means of a limit switch) is still required for the collet as any mechanical blocking would let the clamping pressure rise and the pressure switch would trigger an acknowledge signal. Such a blocking may be caused by e.g. swarf or incorrect positioning of the work piece in the collet
- Control of the release movement of the collet:  
 The clamping modules are usually equipped with pressure switches for consumer ports A and B and the flow pattern symbols B1, W1 etc. are the only exception, where the pressure is monitored only on one side. Therefore the following must be observed:  
 Internal clamping: The control for the machine tool must cope with the situation that the "clamping pressure" will rise although the cylinder for the collet reaches its mechanical stop during a release sequence. Therefore this acknowledged signal from the pressure switch must not be sensed by the control system under this condition (misinterpretation).  
 External clamping: Under this condition the cylinder would have the same direction of movement but this time the acknowledged signal from the pressure switch has to be sensed by the control system as it is a real clamping movement.
- Installation of the pressure switch  
 The plug is provided with a rubber seal, tightening the screw (thread M3) with a torque of 25...30 Nm ensures proper sealing.  
 Procedure if no torque wrench is handy: Screw in the screw until the plug contacts the surface and turn the screw 1.5 turns more.  
**Attention:** Overtightening of the screw may cause mistriggering of the contact switch!  
 The valves are supplied with a tag ex-works which gives the same information and this shouldn't be removed.

## 7. Circuit examples and possible combinations

Example 1: HK43LDT/1M - Z Z2,7/9,8 - AN21F2 - D45 - F50 -BA2 - NSMD2K/GRK/0 - 1 - G24

Compact hydraulic power pack (D 7600-4) with connection blocks (Sk 7881 a. Sk 7788)

Clamping module

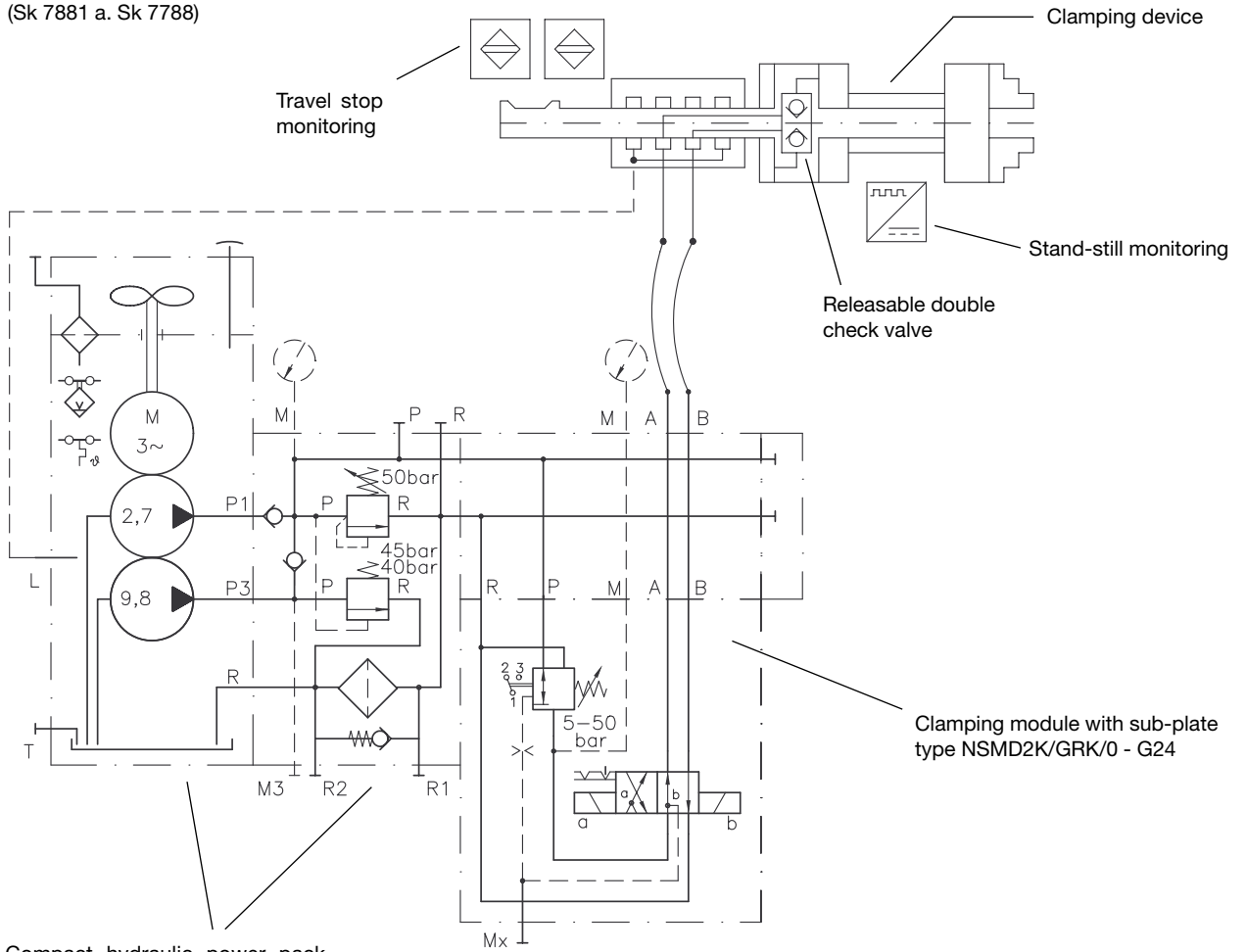

Compact hydraulic power pack with connection block type HK43LDT/1M - Z Z2,7/9,8 - AN21F2 - D45 - F50

Clamping module with sub-plate type NSMD2K/GRK/0 - G24

Example 2: HK43L/1M - Z9,8 - AL21F2 - F60/70 - 2 -BA2 - SMD2K/GRK/B2,5/0 -  
- SMD2 D307/GRK/B2/0 - 11 - G24

Compact hydraulic power pack (D 7600-4)  
 with connection blocks (D 6905 AF/1 and Sk 7788)

Clamping modules

Travel stop monitoring

Clamping device

Tailstock sleeve

Stand-still monitoring

Releasable double  
 check valve

Releasable check valve

$V_o=2l$   
 $p_o=45bar$

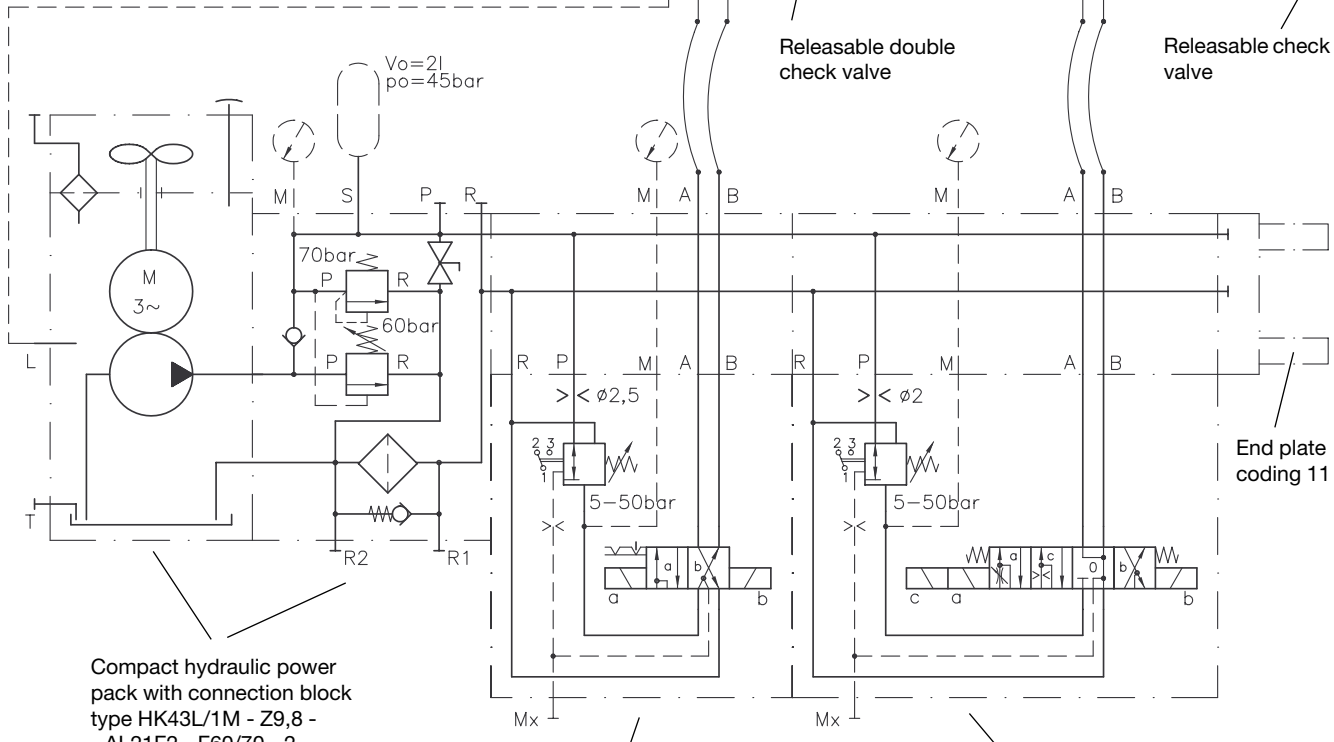

Compact hydraulic power  
 pack with connection block  
 type HK43L/1M - Z9,8 -  
 - AL21F2 - F60/70 - 2

End plate  
 coding 11

Clamping module with sub-plate  
 type SMD2K/GRK/B2,5/0

Clamping module with sub-plate  
 type SMD2 D307/GRK/B2/0 - 11 - G24

Example 3: **HKF438LD/1M - Z11,3 - AL21D D10 - F70/80 - 2 -BA2 - SMD2K/E/B2,5/0 -**  
**- BVZP1F - W2B1,2 W2B1,2/0 - CZ5/20/5 - WN1H/0/22 - 1 - G24**

Compact hydraulic power pack  
 (D 7600-4) with connection blocks  
 (Sk 7881 and Sk 7788)

Clamping module and valve  
 bank BVZP1 (D 7785 B)

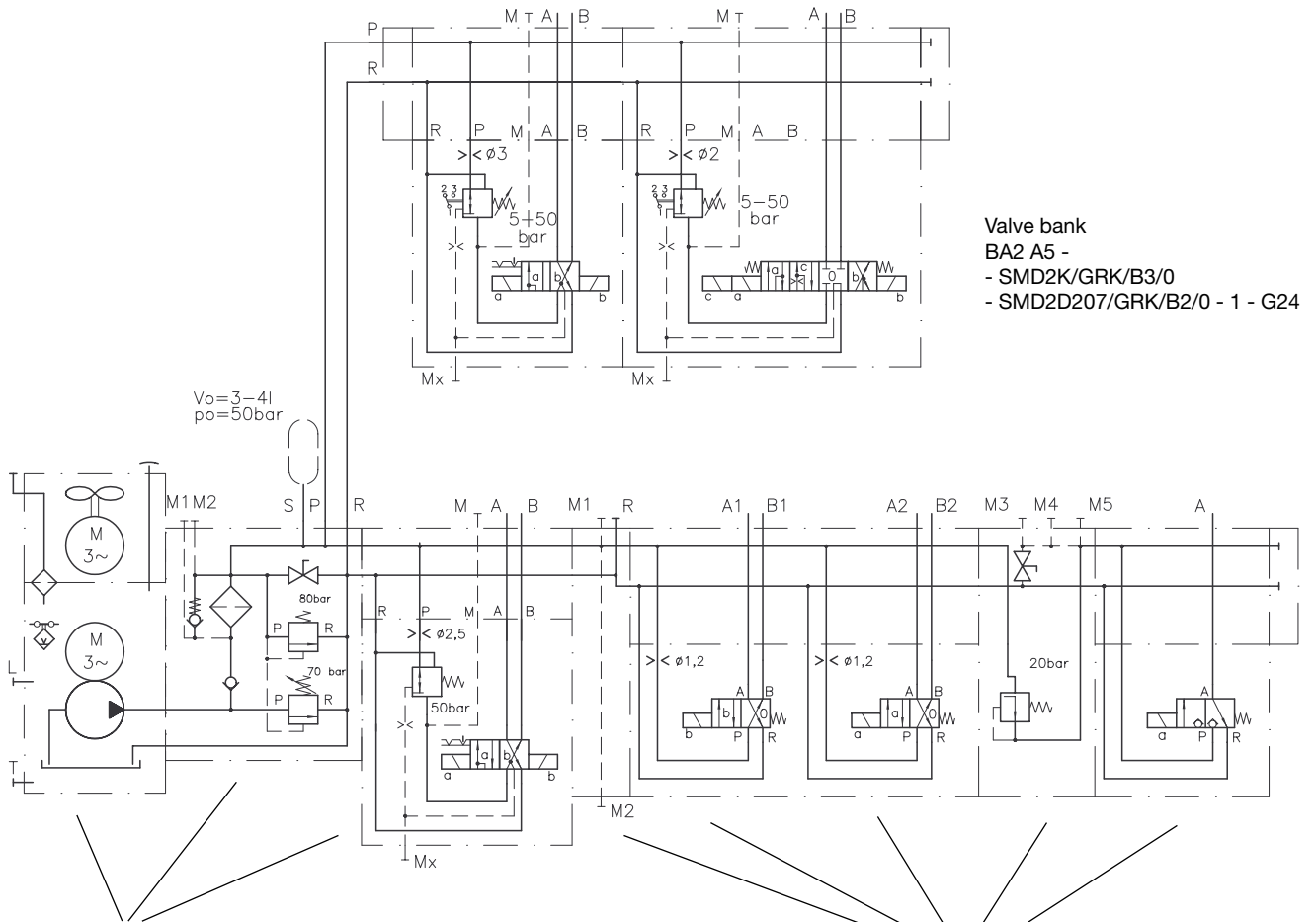

Valve bank  
 BA2 A5 -  
 - SMD2K/GRK/B3/0  
 - SMD2D207/GRK/B2/0 - 1 - G24

Compact hydraulic power pack with connection blocks  
 type HKF438LD/1M - Z11,3 - AL21D D10 - F70/80 - 2  
 - BA2 - SMD2K/E/B2,5/0

Valve bank  
 type BVZP1F - W2B1,2 W2B1,2 /0 - CZ5/20/5 - WN1H/0/22 - 1 - G24