

Additional technical information:

- Compact hydraulic power packs type HK 2 D 7600-2
- Compact hydraulic power packs type HK 3 D 7600-3
- Compact hydraulic power packs type HK 4 and HKF 4 D 7600-4
- Compact hydraulic power packs type HKL 3 and HKLW 3 D 7600-3L

## 1. Notes regarding installation

It is important that you analyze all aspects of your application and review all information concerning this product (see also D 8010) before you select or use any product or system. Due to the variety of operating conditions and applications for these products, the user, through his own analysis and testing, is solely responsible for making the final selection of the products and assuring that all functionality and safety requirements of his application are met. Installation, adjustments, maintenances, and repairs have to be performed by authorized, trained, and instructed staff only.

The use of this product beyond the specified performance limits, with not approved fluids, and/or when non-genuine spare parts installed will lead to an expiration of the guarantee.

The hydraulic power pack can become hot during operation → Risk of injury!

The following guidelines and standards have to be taken additionally into account:

- VDI 3027 "Initial operation and maintenance of hydraulic systems"
- DIN 24346 "Hydraulic systems"
- ISO 4413 "Hydraulic fluid power - General rules relating to systems"
- D 5488/1 Pressure fluids - notes for selection
- B 5488 General operating manual for the assembly, initial operation and maintenance of hydraulic components and systems

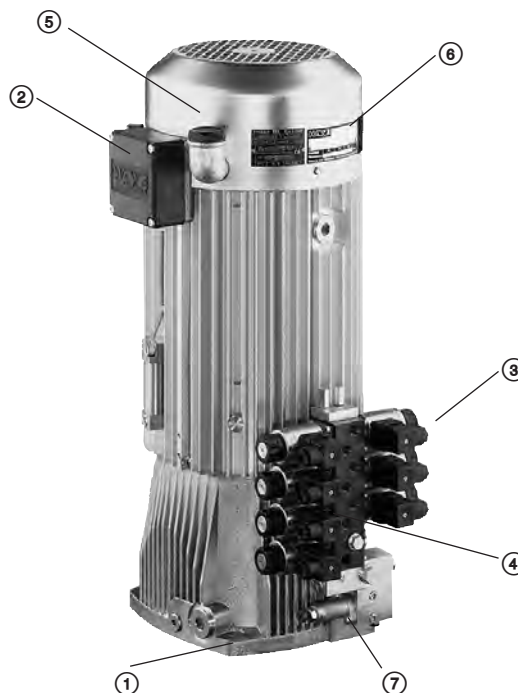

- ① Means of fastening the power pack
- ② Electrical connection of motor and supervision elements (temperature and fluid level switch)
- ③ Electrical connection of valves and supervision elements (e.g. pressure switch)
- ④ Ports for hydraulic connection of consumers
- ⑤ Oil filler and breather filter
- ⑥ Type plate for hydraulic power pack and electric motor
- ⑦ Main pedestal for connecting a valve bank

### Declaration of conformity

Letter of conformity acc. to EC directive 2006/95/EG

"Electrical equipment designed for use within certain voltage limits"

The compact power packs are manufactured in conformity with EN 60 034 (IEC 34 – VDE 0530) and VDE 0110.

**Notes:** Conforming EC directive machinery safety 2006/42/EC, appendix II, section 1 B:

The partly completed machinery are produced conforming the harmonized standards EN 982 and DIN 24 346. The setting in operation is forbidden until it is verified that the machine where the partly completed machinery is utilized fulfills the requirements in safety of Machinery Directive incl. appendix.

### Declaration of incorporation

see page 19

## 2. Coding

Type plate for hydraulic power pack with 3-phase motor

|   |                                |               |    |
|---|--------------------------------|---------------|----|
|  | 2610                           | 030120/01, 01 |    |
|   | HKF 449 DT/1 M-H 4,3-H 4,3-... |               |    |
|   |                                |               |    |
|   |                                |               |    |
|   |                                |               |    |
| ⊕   |                                |               | ⊕  |
| Anschluß / Port   | P1                             | P2            | P3 |
| Vg [cm <sup>3</sup> /U]   | 3,03                           | 3,03          |    |
| p <sub>max</sub> [bar]  | 300                            |               |    |

Type plate for the motor of the hydraulic power packs with 3-phase motor

|  |   |                          |   |
|--|---|--------------------------|---|
| 3~Motor 100L P <sub>N</sub> =2,2kW     |   |                          |   |
| n=1405 min <sup>-1</sup> /f=50Hz       |   | I <sub>N</sub> =4,8/8,3A |   |
| n=1686 min <sup>-1</sup> /f=60Hz       |   | cosφ=0,85                |   |
| ⊕                                      | U <sub>N</sub> =400/230V Y Δ 50Hz IEC38 |                          | ⊕ |
| <b>CE</b>                              |   |                          |   |
| U <sub>N</sub> =460/265V Y Δ 60Hz ± 5% |   |                          |   |
| IP54                                   | I.Cl. B                                 | EN 60034                 |   |

Type plate for fan of the hydraulic power packs type HKF

|                              |            |                            |  |
|------------------------------|------------|----------------------------|--|
| Ventilator – Fan             |            | P <sub>N</sub> =120W       |  |
| U <sub>N</sub> =400/230V Y Δ |            | I <sub>N</sub> =0,25/0,43A |  |
| n=2700min <sup>-1</sup>      |            | f=50Hz                     |  |
| ⊕                            | 50Hz IEC38 | U=360–440V Y/208–254V Δ    |  |
| 60Hz U=380–480V Y/220–277V Δ |            |                            |  |
| IP44                         | I.Cl. F    | EN 60335                   |  |
| Feuchtschutzisolation        |            |                            |  |

- ① Complete type coding
- ② Commission number
- ③ Production date: Week/Year
- ④ Geometric delivery flow of the pump, flow Q (lpm) = Vg · n / 1000
- ⑤ max. perm. operating pressure
- ⑥ Nom. voltage and mains frequency according to circuitry (Y, Δ)  
Voltage ranges (Y, Δ), where the rated performance is available:  
- 50 Hz: ±10% (IEC 38)  
- 60 Hz: ±5%
- ⑦ Nom. power according to mains frequency (50 Hz, 60 Hz)  
**⚠** The actual power consumption can be higher than the nom. power!
- ⑧ Nom. current  
**⚠** The actual current consumption can be higher than the nom. current!
- ⑨ Nom. speed
- ⑩ Data of the auxiliary blower with type HKF  
Nom. voltage, nom. speed, nom. power

## 2.1 Type coding

Order examples:

**HK 24 T /1 - H 0,7 - A 1/380 - 3x400/230V 50Hz**  
**HKF 44 9 DT /1 P1 M - Z 11,3 - C 6 - 3x400/230V 50Hz - G 1/4 x 300**

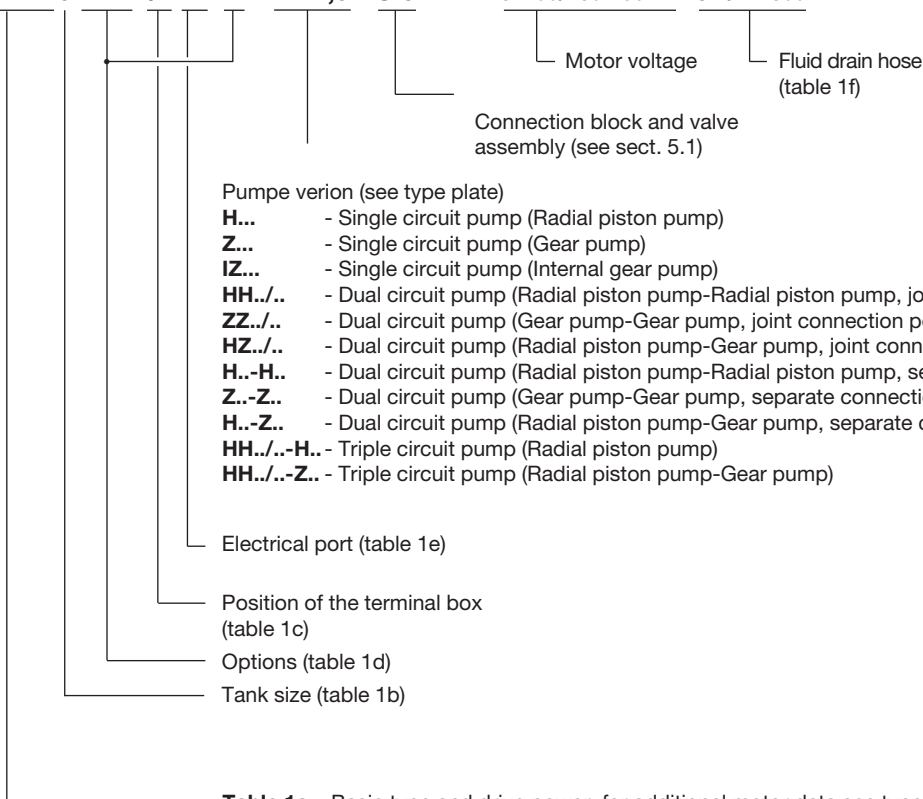

Pumpe verion (see type plate)

- H...** - Single circuit pump (Radial piston pump)
- Z...** - Single circuit pump (Gear pump)
- IZ...** - Single circuit pump (Internal gear pump)
- HH../..** - Dual circuit pump (Radial piston pump-Radial piston pump, joint connection pedestal)
- ZZ../..** - Dual circuit pump (Gear pump-Gear pump, joint connection pedestal)
- HZ../..** - Dual circuit pump (Radial piston pump-Gear pump, joint connection pedestal)
- H..-H..** - Dual circuit pump (Radial piston pump-Radial piston pump, separate connection pedestal)
- Z..-Z..** - Dual circuit pump (Gear pump-Gear pump, separate connection pedestal)
- H..-Z..** - Dual circuit pump (Radial piston pump-Gear pump, separate connection pedestal)
- HH../..-H..** - Triple circuit pump (Radial piston pump)
- HH../..-Z..** - Triple circuit pump (Radial piston pump-Gear pump)

Electrical port (table 1e)

Position of the terminal box (table 1c)

Options (table 1d)

Tank size (table 1b)

**Table 1a:** Basic type and drive power, for additional motor data see type plate

|  | Coding                           | Power (kW)   | Speed (min <sup>-1</sup> )   | Note   |
|--|----------------------------------|--------------|------------------------------|--|
| <b>Note:</b><br>A actual power consumption is load dependent and can be up to 1.8 x nominal power. | <b>HK 24</b>                     | 0.55<br>0.66 | 1350 (50 Hz)<br>1670 (60 Hz) | With integrated fan<br>Basic type HK.V features a moulded stator |
|  | <b>HK 33</b>                     | 0.8<br>0.96  | 1340 (50 Hz)<br>1610 (60 Hz) |  |
|  | <b>HK 34</b>                     | 1.1<br>1.3   | 1410 (50 Hz)<br>1720 (60 Hz) |  |
|  | <b>HK 36</b>                     | 1.5<br>1.8   | 2850 (50 Hz)<br>3430 (60 Hz) |  |
|  | <b>HK 38</b><br><b>HK 38 V</b>   | 2.2<br>2.6   | 1405 (50 Hz)<br>1700 (60 Hz) |  |
|  | <b>HK 43</b><br><b>HK 43 V</b>   | 1.5<br>1.8   | 1395 (50 Hz)<br>1675 (60 Hz) |  |
|  | <b>HK 44</b><br><b>HK 44 V</b>   | 2.2<br>2.6   | 1405 (50 Hz)<br>1700 (60 Hz) |  |
|  | <b>HK 48</b><br><b>HK 48 V</b>   | 3.0<br>3.6   | 1410 (50 Hz)<br>1730 (60 Hz) |  |
|  | <b>HKF 43</b><br><b>HKF 43 V</b> | 1.5<br>1.8   | 1395 (50 Hz)<br>1675 (60 Hz) |  |
|  | <b>HKF 44</b><br><b>HKF 44 V</b> | 2.2<br>2.6   | 1405 (50 Hz)<br>1700 (60 Hz) |  |
|  | <b>HKF 48</b><br><b>HKF 48 V</b> | 3.0<br>3.6   | 1410 (50 Hz)<br>1730 (60 Hz) |  |

**Table 1b:** Tank size  
Connection pedestal, valve assembly, terminal box, options

|           | Basic type                    | Coding       | Filling volume<br>V <sub>fill</sub> (l) | Usable filling volume<br>V <sub>usable</sub> (l) |
|-----------|-------------------------------|--------------|---|--|
| Tank size | <b>HK 2.</b>                  | -            | 2.77                                    | 0.83   |
|           |                               | <b>HK 3.</b> | -                                       | 4.65   |
|           |                               | 8            | 6.1                                     | 2.9  |
|           | <b>HK 4.</b><br><b>HKF 4.</b> | -            | 5.8                                     | 1.9  |
|           |                               | 8            | 8.0                                     | 4.3  |
|           |                               | 5            | 6.8/6.6 <sup>1)</sup>                   | 2.5/1.8 <sup>1)</sup>                            |
|           |                               | 9            | 10.0/9..0 <sup>1)</sup>                 | 5.7/5.5 <sup>1)</sup>                            |
|           |                               | 2            | 15.4                                    | 11.1   |

<sup>1)</sup> Second value for type HK 48. and HKF 48.

**Table 1c:** Terminal box orientation

| Standard   | /1 | /2 | /3 | /4 |
|--|----|----|----|----|
| Alternative coding with type HKF                         | /5 | /6 | /7 | /8 |
| (pump motor and independent blower motor, see sect. 4.3) |    |    |    |    |

Orientation of pump upper housing section incl. terminal box

**Note:** The 4 codings for position of the terminal box influence also the orientation of the upper housing (finned) incl. fluid level gauge, breather etc. (see also dimensional drawings in sect. 4.1)

**Table 1d:** Options

|                    | Coding  | Note   |
|--------------------|---|--|
| Additional options | no coding   | without additional options   |
|                    | <b>S</b>  | Fluid level gauge with float switch (NO-contact)   |
|                    | <b>D</b>  | Fluid level gauge with float switch (NC-contact)   |
|                    | <b>DD</b>   | Fluid level gauge with float switch (NC-contact), 1. switch point: Fluid level 2 l lower than usable volume acc. to table 1b |
|                    | <b>T</b>  | Temperature switch (switch point 80°C)   |
|                    | <b>T60</b>  | Temperature switch (switch point 60°C)   |
|                    | <b>L</b>  | Additional leakage port  |
|                    | <b>R</b>  | Fan shroud with additional protection against coarse debris  |
|                    | <b>M</b>  | with filler neck G 1 1/4   |
|                    | <b>A</b>  | Fluid level gauge with float switch (NC-contact) like D, indiv. electrical connection  |
| <b>W, W60</b>      | Temperature switch, like T, T60, indiv. electrical connection |  |

**Table 1e:** Electrical connection

|                                | Coding             | Note   |
|--------------------------------|--------------------|--|
| Means of electrical connection | no coding          | Standard (Terminal box)  |
|                                | <b>P1, P2</b>      | Plug Co. HARTING   |
|                                | <b>E, P1E, P2E</b> | Electrical connection with additional interference suppression in the terminal box or at the plug Co. HARTING. |

**Table 1f:** Fluid drain hose

| Coding                | Description  |
|-----------------------|--|
| no coding             | Tapped plug G 1/4*, additional: Drain G 3/4* (HK3., HK4., HKF4.) |
| <b>G 1/4* x 300</b>   | Fluid drain hose approx. 300 mm with ball cock                   |
| <b>G 1/4* x 500</b>   | Fluid drain hose approx. 500 mm with ball cock                   |
| <b>G 1/4* W x 300</b> | Fluid drain hose approx. 300 mm with elbow and ball cock         |
| <b>G 1/4* W x 500</b> | Fluid drain hose approx. 500 mm with elbow and ball cock         |

\* BSPP

### 3. Additional parameters

#### 3.1 General

Nomenclature Constant delivery pump  
 Design Valve controlled radial piston pump or gear pump  
 Direction of rotation - Radial piston pump - any  
 - Gear pump - counterclockwise  
 - Internal gear pump - counterclockwise  
 - Type HKF- counterclockwise  
 - (switch two of the three conductors (at 3-phase versions), when there is no flow)  
 Speed range Radial piston pump H: 200 ... 3500 min<sup>-1</sup>  
 Gear pump Z 1,1 ... Z 6,9: 650 ... 3500 min<sup>-1</sup>  
 Z 8,8 ... Z 11,3; Z 14,4: 650 ... 3000 min<sup>-1</sup>  
 Z 12 ... Z 24: 650 ... 3500 min<sup>-1</sup>  
 Internal gear pump IZ 7,5 ... IZ 22,9: 200 ... 3600 min<sup>-1</sup>

Installed position Vertically  
 Mounting see dimensional drawings, sect. 4.1

Mass (weight) (without fluid)

|                 | H<br>HH<br>H-H<br>HH-H | Z, IZ | H-Z<br>HH-Z | ZZ<br>Z-Z |
|-----------------|------------------------|-------|-------------|-----------|
| HK 2.           | 13                     | -     | -           | -         |
| HK 3.           | 20.5                   | 20.5  | -           | -         |
| HK 3.8          | 22.2                   | 22.2  | -           | -         |
| HK 4.           | 29                     | 25.5  | 28.5        | 26.5      |
| HK 4.8          | 34                     | 30.5  | 33.5        | 31.8      |
| HK 4.5, HKF 4.5 | 29.8                   | 26.3  | 27.6        | 29.3      |
| HK 4.9, HKF 4.9 | 34.4                   | 30.9  | 33.9        | 32.2      |
| HKF 482         | 39.2                   | 36.1  | 40.1        | 37.3      |

Mass (weight)

Mass (weight) of connection block and valve bank see respective pamphlet

Hydraulic connection via directly mounted connection blocks, see table in sect. 5.1  
 Basic pump: For connection hole pattern, see sect. 4.3

Running noise Radial piston pump

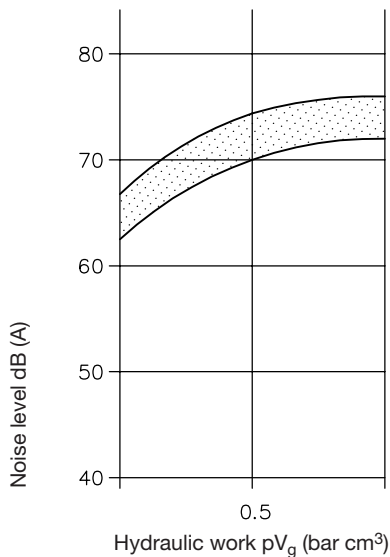

Gear pump

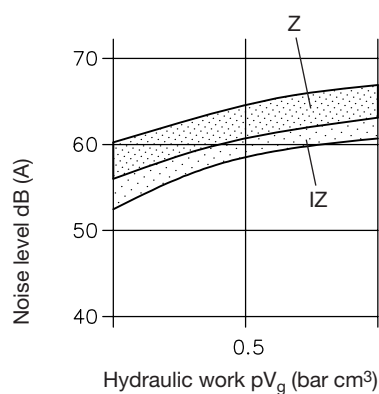

### 3.2 Hydraulic data

|                           |   |
|---------------------------|---|
| Pressure                  | Delivery side (outlet ports P) depending on pump design and delivery flow, see sect. 2.2<br>Suction side (inside the tank): ambient pressure. Not suitable for charging.  |
| Starting against pressure | Versions with 3~phase motor will start-up against pressure $p_{max}$ ! Whereas versions with 1~phase motor will start-up only against slight pressure!  |
| Pressure fluid            | Hydraulic oil conforming DIN 51 524 part 1 to 3; ISO VG 10 to 68 conforming DIN 51 519<br>Opt. operation range: Radial piston pump H: 10 ... 500 mm <sup>2</sup> /s<br>Gear pump Z: 20 ... 100 mm <sup>2</sup> /s<br>Viscosity range: min. approx. 4; max. approx. 800 mm <sup>2</sup> /s<br>Also suitable are biologically degradable pressure fluids type HEES (synth. Ester) at service temperatures up to approx. +70°C. Electrically hazardous: Any fluid types containing water must not be used (short-cut).<br>Must not be used with fluids type HEPG and HETG. |
| Temperature               | Ambient: approx. -40 ... +80°C; Fluid: -25 ... +80°C. Note the viscosity range!<br>Permissible temperature during start: -40°C (observe start-viscosity!), as long as the service temperature is at least 20K higher for the following operation. Biologically degradable pressure fluids: Observe manufacturer's specifications. By consideration of the compatibility with seal material not over +70°C   |
| Filling and usable volume | See tank size in sect. 2.1, table 1b  |

### 3.3 Electrical data

The following data apply to radial piston and to gear pumps  
The drive motor is part of the pump and can not be removed, see description in sect. 1.

|                  |  |
|------------------|--|
| Connection       | Versions with plug Co. HARTING: cable 1.5 mm <sup>2</sup><br>The cable gland M 20x1.5 is customer furnished for versions with terminal box   |
| Protection class | IP 65 acc. to IEC 60529<br><b>Note:</b> The breather filter has to be protected from migrating moisture.   |
| Safety class     | DIN VDE 0100 safety class 1  |
| Insulation       | Lay-out conf. EN 60 664-1<br>● up to 500V AC nom. phase voltage (wire-wire) for 4-wire AC-mains L1-L2-L3-PE (3~phase mains) <b>with</b> earthed star connection point.<br>● up to 300V AC nom. phase voltage (wire-wire) for 3-wire AC-mains L1-L2-L3 (3~phase mains) <b>without</b> earthed star connection point.<br>● for 1~phase mains with 2 conductors L-N up to 300V AC nom. voltage. |
| Suppressor       | Type RC 3 R  |
| Coding E, PE     | Oper. voltage 3x 575 V AC<br>Frequency 10 ... 400 Hz<br>Max. power 4.0 kW  |

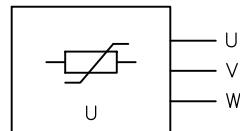

**Current consumption Type HK 24**

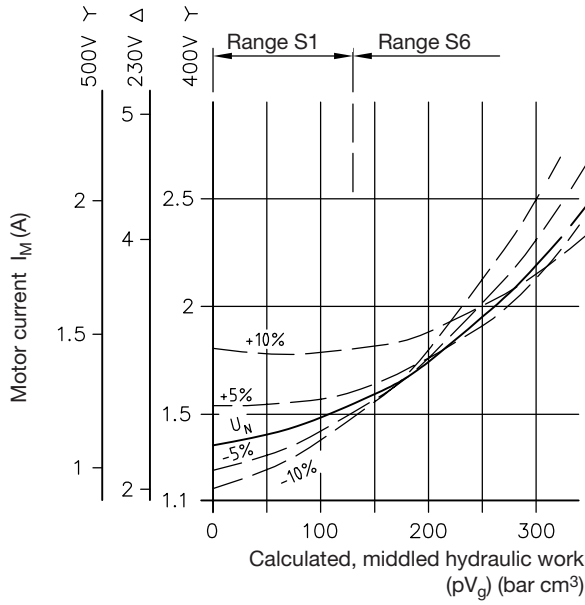

**Type HK 33**

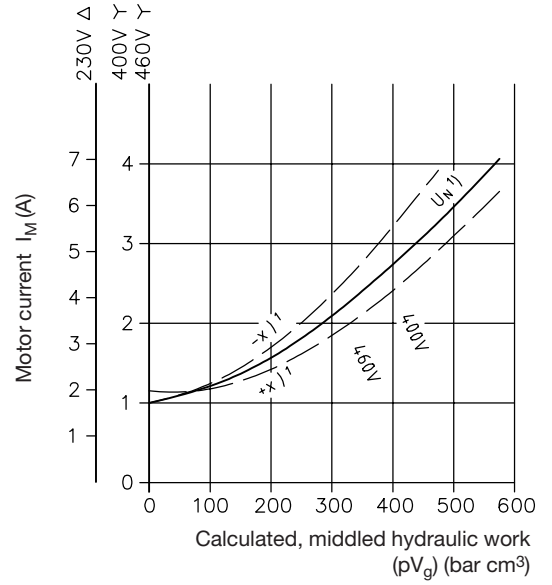

**Type HK 34**

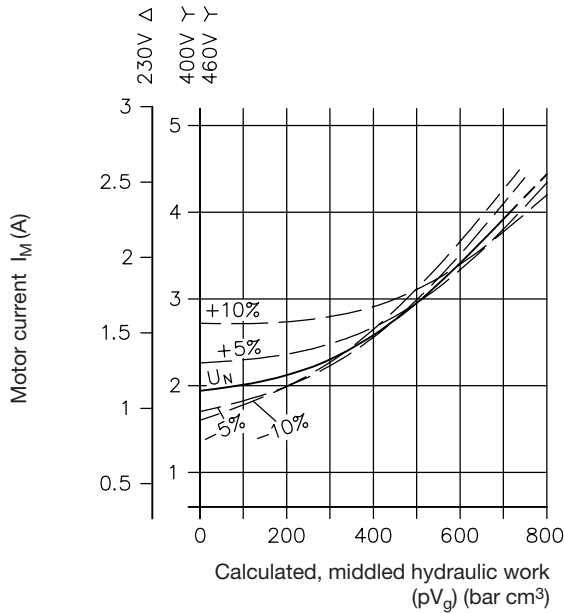

**Type HK 43**

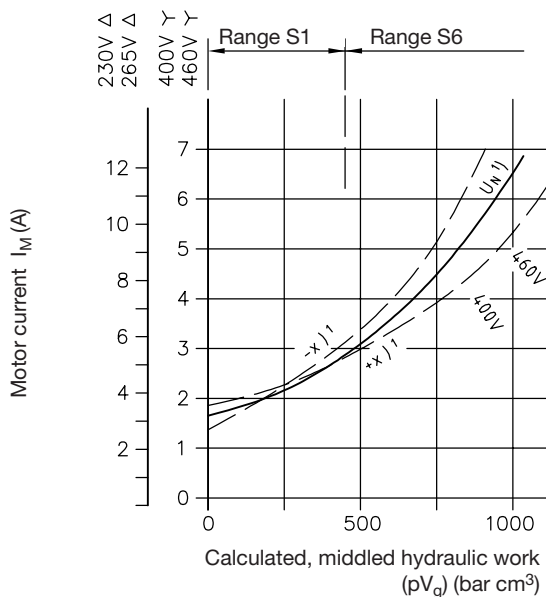

**Type HK 44**

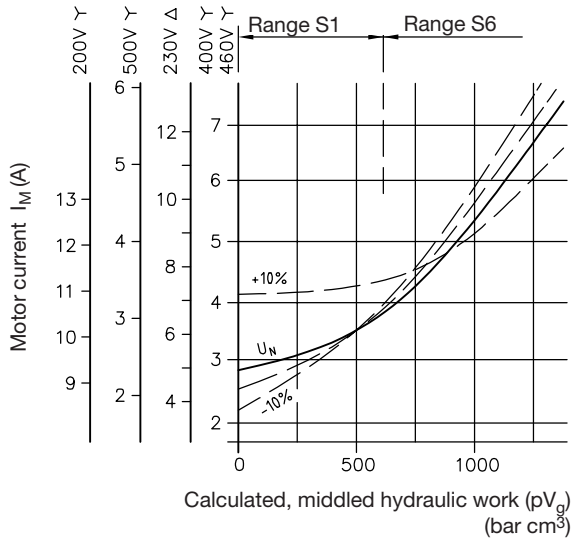

**Type HK 48**

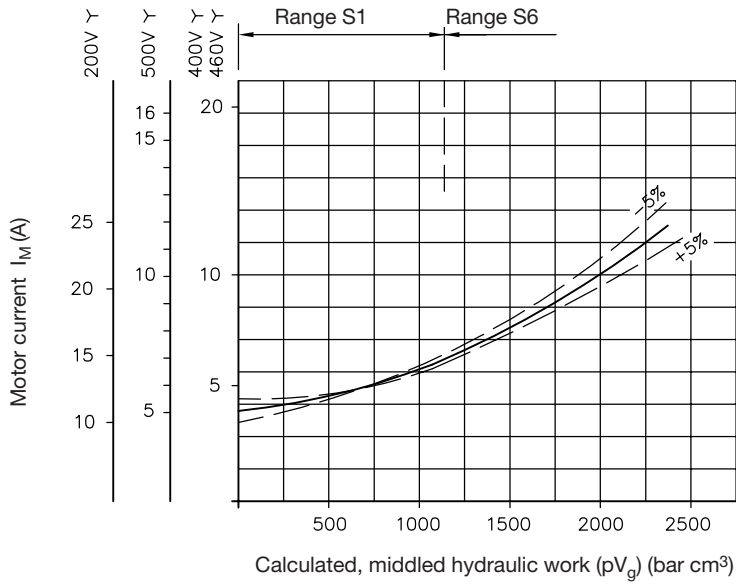



**Aux. blower**  
Coding **HKF**

| Motor data<br>$U_N$               | $P_N(W)$ | Revolutions<br>(rpm) | Protection class |
|-----------------------------------|----------|----------------------|------------------|
| 3x400/230V 50 Hz $\Upsilon\Delta$ | 110      | 2680                 | IP 44            |
| 3x460/265V 60 Hz $\Upsilon\Delta$ | 160      | 2950                 | IP 44            |

Temperature range -10°C ... +50°C  
Electrical connection Inside the terminal box or via plug Co. HARTING (see pos. 4.3)

**Temperature switch**  
Coding **T, T60**  
**W, W60**

Technical data:  
Bimetallic switch

Trigger point 80°C ± 5K (Coding T, W)  
60°C ± 5K (Coding T60, W60)

Max. voltage 250 V 50/60 Hz  
Nom. current (cos φ ~0.6) 1.6 A  
Max. current at 24 V (cos φ = 1) 1.5 A  
Electrical connection see pos. 4.3



**Fluid level gauge with float switch**  
Coding **D, S**

Technical data:  
Max. switched power DC/AC 60 W / 60 VA  
Max. current DC/AC 0.8 A (cos φ =1)  
Max. voltage 230 V 50/60 Hz  
Electrical connection see pos. 4.3

Max. switched power DC/AC 10 W  
Max. current DC/AC 1 A  
Max. voltage 150 V 50/60 Hz  
200 V DC

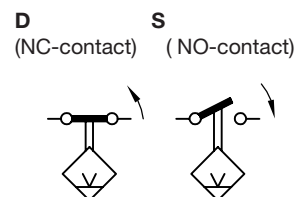

Coding **D, S, A**  
(type HK4.5, HK4.9, HKF4.)

A protective circuitry has to be employed at inductive loads!

## 4. Dimensions

All dimensions in mm, subject to change without notice!

### 4.1 Mounting hole pattern

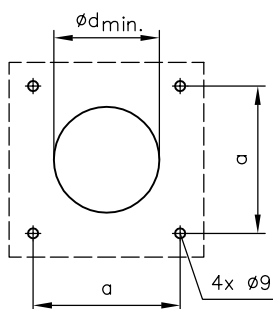

|               | a   | $d_{min}$         |
|---------------|-----|-------------------|
| HK 2          | 150 | -                 |
| HK 3          | 170 | -                 |
| HK 4<br>HKF 4 | 180 | 200 ( $h_1 > 0$ ) |

### Recommended mounting

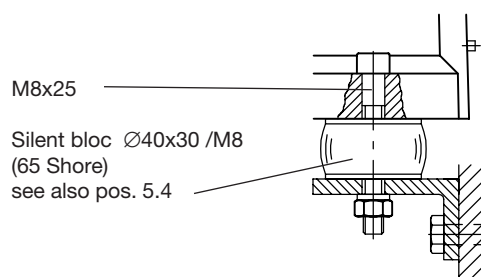

### 4.2 Basic pump

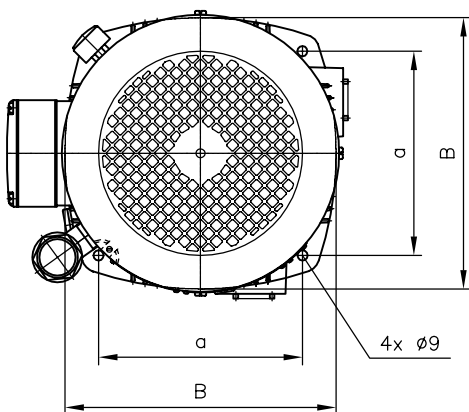
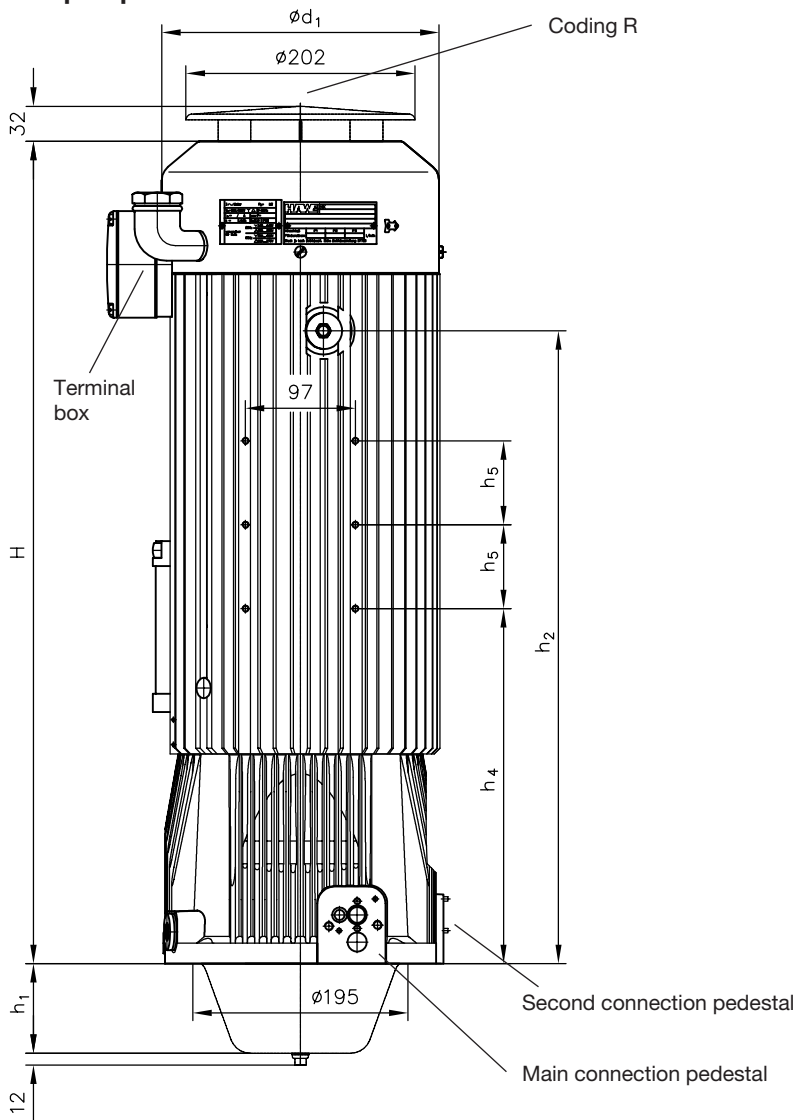

|  |       |
|--|-------|
| Pump version HK 4., HKF 4.   | $h_1$ |
| H, H-H, HH-H, Z (size 1: Z 2... Z 11,3)                            | -     |
| Z (Z 14,4 / size 2: 6,5 ... Z 16),<br>IZ, ZZ, Z-Z, HZ (Z 2,0-11,3) | 79    |
| Z (Z 21, Z 24), HZ (Z 6,5-Z 24)<br>H-Z, HH-Z                       | 103   |

| Basic type | H   | B   | a   | $h_2$ | $h_4$ | $h_5$ | $d_1$ |
|------------|-----|-----|-----|-------|-------|-------|-------|
| HK 2.      | 340 | 196 | 150 | -     | -     | -     | -     |
| HK 3.      | 405 | 212 | 170 | -     | -     | -     | -     |
| HK 3.8     | 495 | 212 | 170 | -     | -     | -     | -     |
| HK 4.      | 460 | 240 | 180 | -     | -     | -     | 219   |
| HK 4.8     | 580 | 240 | 180 | -     | -     | -     | 219   |
| HK 4.5     | 483 | 240 | 180 | 328   | -     | -     | 245   |
| HK 4.9     | 603 | 240 | 180 | 448   | 337   | 74    | 245   |
| HKF 4.5    | 513 | 240 | 180 | 328   | -     | -     | 245   |
| HKF 4.9    | 633 | 240 | 180 | 448   | 337   | 74    | 245   |
| HKF 4.2    | 833 | 240 | 180 | 648   | 337   | 74    | 245   |



**Electrical**

**Terminal box**

**Type HK**

3-phase version, Y-pattern

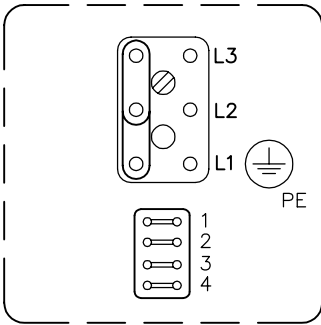

**Type HKF**

3-phase version, Y-pattern

Terminal box position

/1, /2, /3, /4 (table 1c)

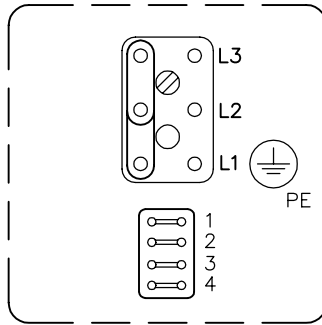

**Type HKF**

Y-or Δ-circuitry ex-works

3-phase motor

Terminal box position

/5, /6, /7, /8 (table 1c)

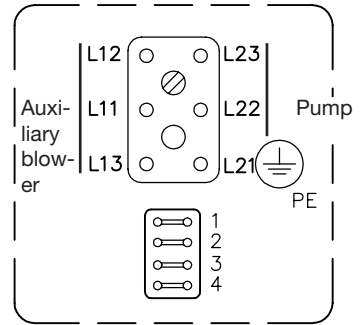

3-phase version, Δ-pattern

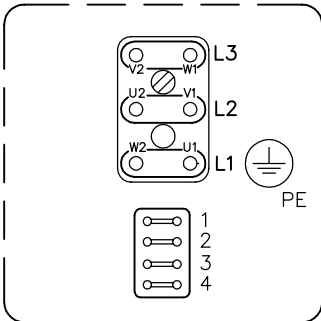

3-phase version, Δ-pattern

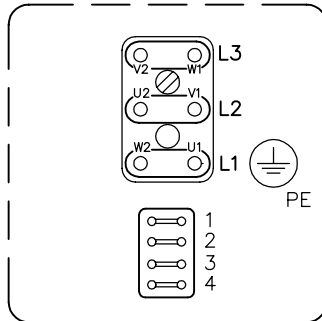

**Plug Co. HARTING HAN 10 E**

Coding P1, P2

**Type HK**

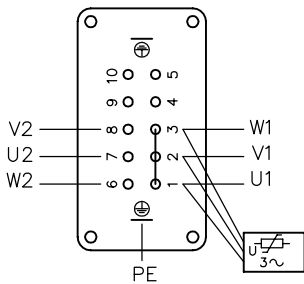

**Sleeve**

Y-pattern

The bridges are to be mounted on site

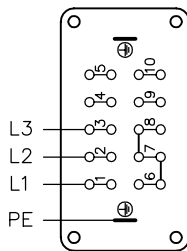

**Sleeve**

Δ-pattern

The bridges are to be mounted on site

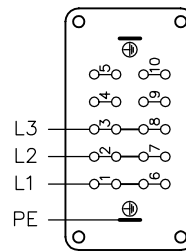

**Type HKF**

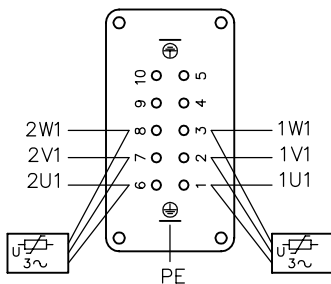

**Sleeve**

Y-or Δ-circuitry ex-works

Terminal box position

/1, /2, /3, /4 (table 1c)

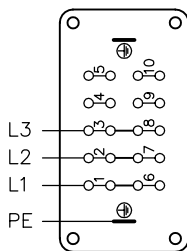

**Sleeve**

Y-or Δ-circuitry ex-works

Terminal box position

/5, /6, /7, /8 (table 1c)

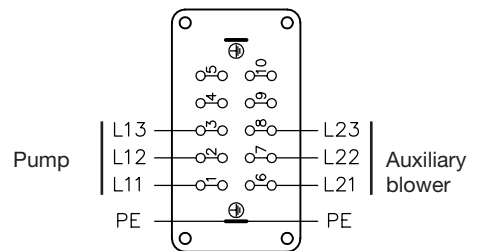

Circuitry for terminal box

**Temperature switch**

Coding **T, T60**

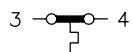

**Float switch**

Coding **S, D**

**S** (NO-contact)

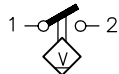

**D** (NC-contact)

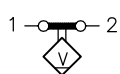

Coding **S-T**

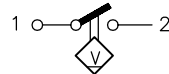
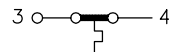

Coding **DT**

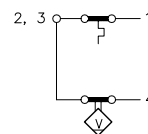

Coding **D-T**

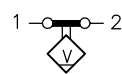
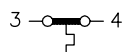

Coding **DD**

1. Switch point



2. Switch point

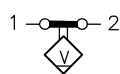

Coding **DDT**

1. Switch point



2. Switch point

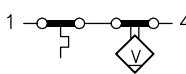

Circuitry for plug Co. HARTING

**Temperature switch**

Coding **T, T60**

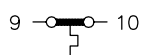

**Float switch**

Coding **S, D**

**S** (NO-contact)

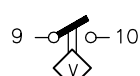

**D** (NC-contact)

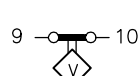

Coding **S-T**

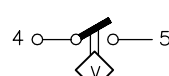
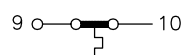

Coding **DT**

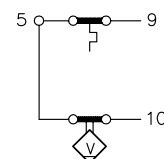

Coding **D-T**

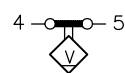
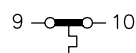

Coding **DD**

1. Switch point



2. Switch point

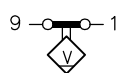

Coding **DDT**

1. Switch point



2. Switch point

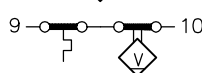

**Temperature switch**

(connected indiv.)

Coding **W, W60**

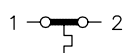

**Float switch**

(connected indiv.)

Coding **A**

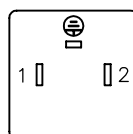
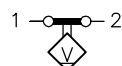

Plug conf.  
DIN EN 175 301-803 C  
(8 mm)

## 5. Appendix

### 5.1 Notes regarding selection

The procedure for selection and layout of compact hydraulic power packs with directly mounted valve banks is detailed in the respective pamphlets for the compact hydraulic power pack.

#### a) Additional leakage return port

For significant, leakage return flow at operation temperature, e.g. chucks of lathes. This leakage return flow is routed in such a way that the transported heat is dissipated via the fan.

This leakage return flow is integral part of the finned housing with type HK 4.5, HK 4.9, HKF 4.5, HKF 4.9 and HKF 482. An additional leakage return port at the second connection pedestal is available with all other versions, coding **L** acc. to table 1d.

#### b) Auxiliary tanks

It is possible to increase the usable volume by connecting an auxiliary tank at port T. It should be used for volume compensation only. These tanks are to be customer furnished. The reflow pipe from the consumer circuit has to be connected at port R (connection pedestal)!

The connection pipe has to be dimensioned sufficiently. The connection should be either by means of a hose only or with fittings for pipe 22x1.5 and a piece of hose to decouple the noise.

**Note:** Do not use for pump delivery flows higher than 12 lpm !

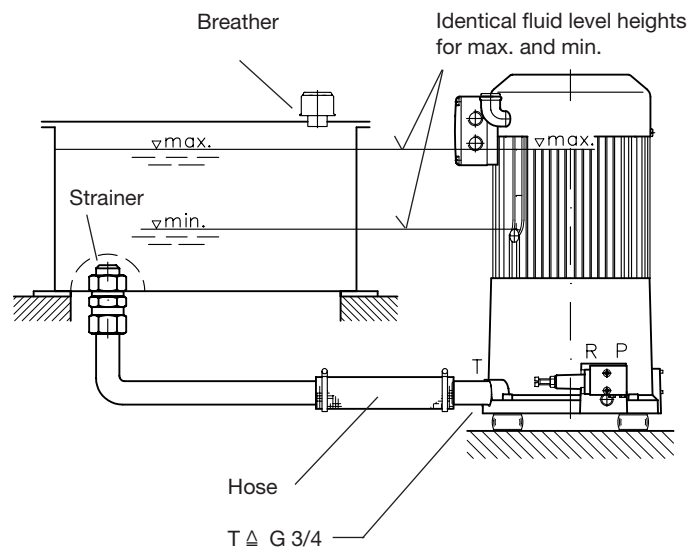

**c) Technical description of the connection blocks**

A connection block is mandatory for the hydraulic connection of the hydraulic power pack.

| Type                             | Description  | Pamphlet   |
|----------------------------------|--|------------|
| <b>A, AL, AM, AK, AS, AV, AP</b> | For single circuit pumps with pressure limiting valve and the possibility for direct mounting of directional valve banks<br>Optional:<br>- pressure resistant filter or return filter<br>- idle circulation valve<br>- accumulator charging valve<br>- prop. pressure limiting valve | D 6905 A/1 |
| <b>AN, AL, NA, C30, SS, VV</b>   | For dual circuit pumps with pressure limiting valve and where directional valve banks can be directly mounted in some cases<br>Optional:<br>- accumulator charging valve<br>- two stage valve<br>- idle circulation valve  | D 6905 A/1 |
| <b>AX</b>                        | For single circuit pumps with pressure limiting valve (type approved) and the possibility for direct mounting of directional valve banks for use at accumulator charged systems<br>Optional:<br>- pressure resistant filter or return filter<br>- idle circulation valve             | D 6905 TÜV |
| <b>B</b>                         | For single circuit pumps for actuating single acting cylinders with pressure limiting valve and drain valve<br>Optional:<br>- throttle valve   | D 6905 B   |
| <b>C</b>                         | For single circuit pumps with ports P and R for direct piping  | D 6905 C   |

**d) Technical description of the directional valve banks**

The direct mounting of directional valves to the connection blocks type A enables creation of compact hydraulic units without additional piping.

| Type            | Description  | Pamphlet       |
|-----------------|--|----------------|
| <b>VB</b>       | Directional seated valves up to 700 bar  | D 7302         |
| <b>BWN, BWH</b> | Directional seated valves up to 450 bar  | D 7470 B/1     |
| <b>BVZP</b>     | Directional seated valves up to 450 bar  | D 7785 B       |
| <b>SWR, SWS</b> | Directional spool valves up to 315 bar   | D 7451, D 7951 |
| <b>BA</b>       | Valve bank for the combination of different directional valves with connection hole pattern NG 6 acc. to DIN 24 340-A6 | D 7788         |
| <b>BVH</b>      | Valve bank with directional seated valves up to 400 bar  | D 7788 BV      |
| <b>NBVP</b>     | Directional seated valves  | D 7765 N       |
| <b>NSWP</b>     | Directional spool valves   | D 7451 N       |
| <b>NSMD</b>     | Clamping modules (Directional spool valve with pressure reducing valve and feedback signal)                            | D 7787         |
| <b>NZP</b>      | Intermediate plate with connection hole pattern Ng 6 acc. to DIN 24 340-A6   | D 7788 Z       |

## 5.2 Assembly and installation notes

**Attention:** The compact hydraulic power pack has to be installed and connected by a qualified technician, who is familiar with and works according to the generally accepted engineering standards and the latest legal regulations and standards.

The following guidelines and standards have to be taken into account:

- VDI 3027 "Initial operation and maintenance of hydraulic systems"
- DIN 24346 "Hydraulic systems"
- ISO 4413 "Hydraulic fluid power -- General rules relating to systems"
- D 5488/1 Pressure fluids - notes for selection
- B 5488 General operating manual for the assembly, initial operation and maintenance of hydraulic components and systems

### a) Identification

see type plate or selection table in section 2

### b) Installation and mounting

#### ● Installation

The hydraulic power pack incl. the solenoids of the directional valves can become hot during operation → Risk of injury!



Care has to be taken that fresh air can be drawn in and the warm air can escape.

Modifications of any kind (mechanical, welding or soldering works) must not be performed.

- Installation position vertically
- For dimensions, see sect. 4.2
- For mounting hole pattern, see sect. 4.1
- Recommended mounting

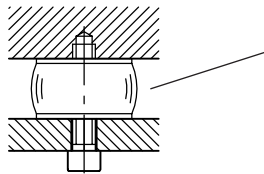

Silent bloc Ø40x30 /M8 (65 Shore)

- For mass (weight) of the connection blocks and valve banks see the respective pamphlets  
Mass (weight) of the connection blocks and valve banks, see the respective pamphlets.

|                 | <b>H</b><br><b>HH</b><br><b>H-H</b><br><b>HH-H</b> | <b>Z, IZ</b> | <b>H-Z</b><br><b>HH-Z</b> | <b>ZZ</b><br><b>Z-Z</b> |
|-----------------|--|--------------|---------------------------|-------------------------|
| HK 2.           | 13   | -            | -                         | -                       |
| HK 3.           | 20.5   | 20.5         | -                         | -                       |
| HK 3.8          | 22.2   | 22.2         | -                         | -                       |
| HK 4.           | 29   | 25.5         | 28.5                      | 26.5                    |
| HK 4.8          | 34   | 30.5         | 33.5                      | 31.8                    |
| HK 4.5, HKF 4.5 | 29.8   | 26.3         | 27.6                      | 29.3                    |
| HK 4.9, HKF 4.9 | 34.4   | 30.9         | 33.9                      | 32.2                    |
| HKF 482         | 39.2   | 36.1         | 40.0                      | 37.3                    |

### c) Electrical connection and setting of the protective motor switch

- For connection of the electric motor, see sect. 4.3
- For connection of the float and fluid level switch, see sect. 4.3

**Note:** The temperature switch will trigger at a fluid temperature of approx. 95°C.

**Note:** The signal has to be delayed sufficiently (time lag relay) if the lay-out of the system features an operation cycle where the pump is emptied below the min. level and replenished by the reflow from the consumer within one cycle.

#### ● Adjustment of the protective motor switch

- S1-operation mode (for pressure  $\leq p_1$ )

The protective motor switch should be set for the corresponding current, required to achieve the adjusted pressure of the pressure limiting valve (see  $I_M$ -(pV) calc.- curve sect. 3.3), however not higher than the nom. current  $I_N$ . This motor protection covers only a possible mechanical blockade of the motor.

- S 6- operation mode (for pressure  $\leq p_{max}$ )

In most cases it is sufficient, to set the response current to approx. (0.85...0.9) of  $I_N$ . This makes sure that on one hand the bimetallic switch does not trigger too early during normal operation but on the other hand the oil temperature doesn't rise too high due to a prolonged response time after the pressure limiting valve is in action.

- Test the setting of the motor protective switch during a test run. Temperature switches, float switches and pressure switches are further safety measures against malfunctions.

### d) Notes to ensure EMC (Electromagnetic compatibility)

No impermissible spikes are emitted (EN 60034-1 sect. 19) when hydraulic power packs (inductive motor acc. to EN 60034-1 sect. 12.1.2.1) are connected to a system (e.g. power supply acc. to EN 60034-1 sect. 6). Tests regarding the conformity with EN 60034-1 sect. 12.1.2.1 and/or VDE 0530-1 are not required. Electro-magnetic fields may be generated during switching the motor ON/OFF. This effect can be minimized by means of a filter e.g. type 23140, 3 · 400 V AC 4 kW 50-60 Hz (Co. MURR-ELEKRONIK, D-71570 Oppenweiler)

There is an optional suppressor (coding E, P1E or P2E, see sect. 2.1, table 1e), which can be directly mounted either at the terminal box or at the plug Co. HARTING (see table 1e)

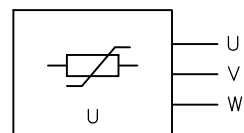



**e) Putting into operation**

- Check, whether the compact hydraulic power pack is professionally connected.
  - Electrically: Power supply, controls
  - Hydraulically: Piping, hoses, cylinders, motors
  - Mechanically: Fastening at the machine, the frame, and the rack
- A protective motor switch should be employed to safeguard the electric motor. For current setting, see sect. 5.2 c
- The pressure fluid to top-up the power pack should have passed the system filter or be fed via a filter unit always. Only mineral oils conforming DIN 51524 part 1 to 3, type HL or HLP, with a viscosity of ISO VG 10 to 68 acc. to DIN 51519 are suited for use with this power pack.
 

**Note:**  
The water content must not exceed 0.1% (Danger of short-cut!)  
Also suitable are biologically degradable pressure fluids type HEES (synth. ester) at service temperatures up to approx. +70°C. Electrically hazardous: Any fluid types containing water must not be used (short-cut) i.e. fluids type HEPG and HETG are not suitable! The compact hydraulic power pack has to be topped-up to the max. marking of the fluid level gauge/dip-stick.
- Filling volume / Usable filling volume

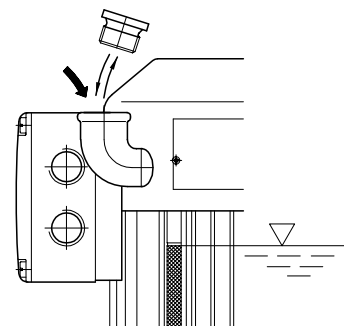

|           | Basic type                    | Coding | Filling volume V <sub>fill</sub> (l) | Usable filling vol. vertically V <sub>fill</sub> (l) |
|-----------|-------------------------------|--------|--------------------------------------|--|
| Tank size | <b>HK 2.</b>                  | -      | 2.77                                 | 0.83   |
|           | <b>HK 3.</b>                  | -      | 4.65                                 | 1.45   |
|           |                               | 8      | 6.1                                  | 2.9  |
|           | <b>HK 4.</b><br><b>HKF 4.</b> | -      | 5.8                                  | 1.9  |
|           |                               | 8      | 8.0                                  | 4.3  |
|           |                               | 5      | 6.8/6.6 <sup>1)</sup>                | 2.5/1.8 <sup>1)</sup>                                |
|           |                               | 9      | 10.0/9.0 <sup>1)</sup>               | 5.7/5.5 <sup>1)</sup>                                |
|           |                               | 2      | 15.4                                 | 11.1   |

<sup>1)</sup> Second valve for type HK 48. and HKF 48.

- Direction of rotation
  - Radial piston pump - any
  - Gear pump - counterclockwise
  - Type HKF- counterclockwise
  - (The intended rotation direction is indicated by an arrow at the fan shroud; Switch two of the three conductors (at 3-phase versions), when there is no flow.)
- Initial operation and bleeding
 

The pump cylinders will be bled automatically if the pump is switched on and off several times while the connected directional valves are switched into a switching position where idle circulation is provided, if possible with your circuitry (see circuit diagram). Another way is to install a pipe fitting with a short piece of pipe and prolonged by a translucent tube. The other end of the tube should be put into the filler neck (breather removed), held firmly and sealed with a non-fluffing cloth. Now switch on the pump and let it run until no more bubbles are visible. Next after the pump cylinders are bled any air dragged into the system should be removed by opening the bleeder screws at the consumers (if provided) until no more bubble are detected or by operating all functions of the circuitry without load until all cylinders, motors, etc. move steadily and without any hesitation.
- Pressure limitation and pressure reducing valves
 

Do not make any changes of the pressure setting without simultaneously checking the pressure with a pressure gauge!
- Directional valves
 

Solenoid valves apparent are to be connected to the controls according to the hydraulic wiring diagram and functional diagram.
- Accumulator charged systems
 

Accumulators have to be filled with appropriate equipment according to the pressure specifications of the hydraulic wiring diagram. The respective operating manuals have to be taken into account.

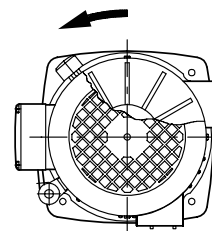

**5.3 Servicing**

The hydraulic power packs type MP and the valves being directly mounted onto the hydraulic power pack are almost maintenance free. Only the fluid level should be checked regularly depending on operation conditions. The fluid should be replaced every year as a general rule, but more frequently if tests show aging or contamination, filters (pressure or return) have to be replaced accordingly.

- Attention:** Prior to maintenance and repair works the system has to be:
- depressurized (hydraulic side). This applies especially to systems with hydraulic accumulators!
  - cut-off or deenergized

Repairs and spare parts

- Repairs (replacing service items) are possible by competent craftsmen. The motor can't be repaired or replaced by the customer. There are spare parts lists available, pls. state your pump type acc. to the type plate either on the pump or on the cover plate.

## **6. Additional information**

**6.1 Declaration of incorporation according to Machinery Directive 2006/42/EC (see page 19)**

**6.2 Declaration of conformity according to Low-Voltage Directive 2006/95/EC (see page 20)**

### **6.3 UL-compliant stators**

The following stator types are UL-compliant.

UL reference: E 68554

- HK 2.

**Einbauerklärung einer unvollständigen Maschine - Original**

nach Maschinenrichtlinie 2006/42/EG, Anhang II B

**Declaration of incorporation of partly completed machinery – original**

according to machinery directive 2006/42/EC, Annex II B

Hersteller:  
Manufacturer:HAWE Hydraulik SE  
Einsteinring 17  
DE-85609 Aschheim/MünchenDie alleinige Verantwortung für die Ausstellung dieser Einbauerklärung trägt der Hersteller.  
*This declaration of incorporation is issued under the sole responsibility of the manufacturer.*Unvollständige Maschine:  
Partly completed machinery:**Typ HK(F) 3(4) nach unserer Dok. D 7600-3(4)**  
*Type HK(F) 3(4) acc. to our doc. D 7600-3(4)*Die folgenden grundlegenden Sicherheits- und Gesundheitsschutzanforderung der Richtlinie 2006/42/EG kommen zur Anwendung:  
*The following essential health and safety requirements of Directive 2006/42/EC apply:***Abschnitte (chapters) 1.1.2, 1.1.3, 1.1.5, 1.2 komplett (complete), 1.3.1, 1.3.2, 1.3.4, 1.3.6, 1.3.7, 1.5.1, 1.5.2, 1.5.3, 1.5.4, 1.5.5, 1.5.6, 1.5.8, 1.5.9, 1.5.16, 1.6.3, 1.7.1, 1.7.3, 1.7.4 und 1.7.4.3.**Es wurden folgende harmonisierte Normen oder andere technische Spezifikationen zugrunde gelegt:  
*The following harmonized standards or other technical specifications have been applied:***DIN EN ISO 12100:2011-03**Dokumentationsbevollmächtigter:  
Person authorised to compile the technical file:HAWE Hydraulik SE  
Abt. Produktmanagement  
Einsteinring 17  
D-85609 Aschheim/MünchenDie speziellen technischen Unterlagen nach Anhang VII Teil B wurden erstellt.  
*The relevant technical documentation is compiled in accordance with part B of Annex VII.*Der Hersteller verpflichtet sich, die speziellen technischen Unterlagen zur unvollständigen Maschine einzelstaatlichen Stellen auf Verlangen elektronisch zu übermitteln.  
*The manufacturer undertakes to electronically transmit the special technical documents on the partly completed machinery to national authorities on request.*Die unvollständige Maschine darf erst dann in Betrieb genommen werden, wenn festgestellt wurde, dass die Maschine, in die die unvollständige Maschine eingebaut werden soll, den Bestimmungen der Richtlinie 2006/42/EG entspricht.  
*The partly completed machinery must not be put into service until the final machinery into which it is to be incorporated has been declared in conformity with the provisions of the directive 2006/42/EG.*

Aschheim, 2022-08-05

  
Axel Schwerdtfeger, CTO  
Dogan Basöz, Product ManagerHAWE Hydraulik SE, Einsteinring 17, D-85609 Aschheim/München, info@hawe.de, Tel. +49 89 379100-1000, Fax +49 89 379100-91000  
Europäische Aktiengesellschaft (SE) - Sitz der Gesellschaft: München - USt ID Nr: DE180016108 - Registergericht München HRB 174760  
Vorstand: Robert Schullan, Axel Schwerdtfeger, Wolfgang Sochor, Markus Unterstein, Jiang Ye  
Vorsitzender des Aufsichtsrats: Karl Haeusgen  
Hypo-Vereinsbank München, 1780008454 (BLZ 700 202 70), IBAN DE53 7002 0270 1780 0084 54, BIC HYVEDEMMXXX  
Commerzbank München, 150623700 (BLZ 700 400 41), IBAN DE56 7004 0041 0150 6237 00, BIC COBADEFFXXX  
Baden-Württembergische Bank, 2368049 (BLZ 600 501 01), IBAN DE90 6005 0101 0002 3680 49, BIC SOLADEST  
Bayerische Landesbank, 203693428 (BLZ 700 500 00), IBAN DE86 7005 0000 0203 6934 28, BIC BYLADEMXXXZertifiziert nach  
ISO 9001  
ISO 14001  
ISO 50001  
ISO 45001  
[www.hawe.com](http://www.hawe.com)

**Declaration of incorporation of partly completed machinery – original**

according to Supply of Machinery (Safety) Regulations 2008, 2008 No. 1597, annex II B

**Einbauerklärung einer unvollständigen Maschine - Original**

nach Supply of Machinery (Safety) Regulations 2008, 2008 No. 1597, Anhang II B

Manufacturer:

HAWE Hydraulik SE

Hersteller:

Einsteinring 17

DE-85609 Aschheim/München

This declaration of incorporation is issued under the sole responsibility of the manufacturer.

*Die alleinige Verantwortung für die Ausstellung dieser Einbauerklärung trägt der Hersteller.*

Partly completed machinery:

**Type HK 3(4) acc. to our documentation D 7600-3(4)**

Unvollständige Maschine:

Typ HK 3(4) nach unserer Dokumentation D 7600-3(4)

The following essential health and safety requirements of Directive 2008 No. 1597 apply:

*Die folgenden grundlegenden Sicherheits- und Gesundheitsschutzanforderung der Richtlinie 2008 No. 1597 kommen zur Anwendung:***Chapters (Abschnitte) 1.1.2, 1.1.3, 1.1.5, 1.2 complete (komplett), 1.3.1, 1.3.2, 1.3.4, 1.3.6, 1.3.7, 1.5.1, 1.5.2, 1.5.3, 1.5.4, 1.5.5, 1.5.6, 1.5.8, 1.5.9, 1.5.16, 1.6.3, 1.7.1, 1.7.3, 1.7.4 and 1.7.4.3.**

The following designated standards or other technical specifications have been applied:

*Es wurden folgende harmonisierte Normen oder andere technische Spezifikationen zugrunde gelegt:***DIN EN ISO 12100:2011-03**

Person authorised to compile the technical file:

Dokumentationsbevollmächtigter:

Koppen &amp; Lethem Ltd

3 Glenholm Park, Brunel Drive

Newark | Nottinghamshire | NG24 2EG

United Kingdom

The relevant technical documentation is compiled in accordance with part B of Annex VII.

*Die speziellen technischen Unterlagen nach Anhang VII Teil B wurden erstellt.*

The manufacturer undertakes to electronically transmit the special technical documents on the partly completed machinery to national authorities on request.

*Der Hersteller verpflichtet sich, die speziellen technischen Unterlagen zur unvollständigen Maschine einzelstaatlichen Stellen auf Verlangen elektronisch zu übermitteln.*

The partly completed machinery must not be put into service until the final machinery into which it is to be incorporated has been declared in conformity with the provisions of the directive 2008 No. 1597.

*Die unvollständige Maschine darf erst dann in Betrieb genommen werden, wenn festgestellt wurde, dass die Maschine, in die die unvollständige Maschine eingebaut werden soll, den Bestimmungen der Richtlinie 2008 No. 1597.*

Aschheim, 2022-08-05

  
Axel Schwerdtfeger, CTO  
Dogan Basöz, Product Manager

HAWE Hydraulik SE . Einsteinring 17 . D-85609 Aschheim/München . info@hawe.de . Tel. +49 89 379100-1000 . Fax +49 89 379100-91000

Europäische Aktiengesellschaft (SE) . Sitz der Gesellschaft: München . USt ID Nr: DE180016108 . Registergericht München HRB 174760

Vorstand: Robert Schüllan, Axel Schwerdtfeger, Wolfgang Sochor, Markus Unterstein, Jiang Ye

Vorsitzender des Aufsichtsrats: Karl Haeusgen

Hypo-Vereinsbank München, 1780008454 (BLZ 700 202 70), IBAN DE53 7002 0270 1780 0084 54, BIC HYVEDEMMXXX

Commerzbank München, 150623700 (BLZ 700 400 41), IBAN DE56 7004 0041 0150 6237 00, BIC COBADEFFXXX

Baden-Württembergische Bank, 2368049 (BLZ 600 501 01), IBAN DE90 6005 0101 0002 3680 49, BIC SOLADEST

Bayerische Landesbank, 203693428 (BLZ 700 500 00), IBAN DE86 7005 0000 0203 6934 28, BIC BYLADEMMXXX

Zertifiziert nach

ISO 9001

ISO 14001

ISO 50001

ISO 45001

www.hawe.com

**EU- Konformitätserklärung - Original**  
**EU Declaration of conformity - original**

Hersteller:  
Manufacturer:

HAWE Hydraulik SE  
Einsteinring 17  
DE-85609 Aschheim/München

Die alleinige Verantwortung für die Ausstellung dieser Konformitätserklärung trägt der Hersteller.  
*This declaration of conformity is issued under the sole responsibility of the manufacturer.*

Produkt:  
Product:

**Typ HK(F) 3(4) nach unserer Dokumentation**  
**D 7600-3(4)**  
*Type HK(F) 3(4) acc. to our documentation D 7600-3(4)*

Gegenstand der Erklärung:  
Object of the declaration:

Unterölmotor des Hydraulikaggregates  
*Immersed Motor of hydraulic power pack*

Der oben beschriebene Gegenstand der Erklärung erfüllt die einschlägigen Harmonisierungsrechtsvorschriften der EU:  
*The object of the declaration described above is in conformity with the relevant European Union harmonization legislation:*

**2014/35/EU**

Es wurden folgende harmonisierte Normen oder andere technische Spezifikationen zugrunde gelegt:  
*The following harmonized standards or other technical specifications have been applied:*

**DIN EN 60204-1 VDE0113-1:2019-06**

Aschheim, 2022-08-05

  
Axel Schwerdtfeger, CTO

  
Dogan Basöz, Product Manager

**UKCA-Declaration of conformity - original**  
**UKCA Konformitätserklärung - Original**Manufacturer:  
*Hersteller:*HAWE Hydraulik SE  
Einsteinring 17  
DE-85609 Aschheim/MünchenThis declaration of conformity is issued under the sole responsibility of the manufacturer.  
*Die alleinige Verantwortung für die Ausstellung dieser Konformitätserklärung trägt der Hersteller.*Product:  
*Produkt:***Type HK(F) 3(4) acc. to our documentation**  
**D 7600-3(4)**  
Typ HK(F) 3(4) nach unserer Dokumentation D 7600-3(4)Object of the declaration:  
*Gegenstand der Erklärung*Immersed Motor of hydraulic power pack  
*Unterölmotor des Hydraulikaggregates*The object of the declaration described above  
complies with the relevant designated standards  
of the United Kingdom:  
*Der oben beschriebene Gegenstand der Erklärung erfüllt die  
entsprechenden Harmonisierungsrechtsvorschriften des UK:***Electrical Equipment (Safety) Regulations 2016**  
**No. 1101**The following designated standards or other  
technical specifications have been applied:  
*Es wurden folgende harmonisierte Normen oder andere  
technische Spezifikationen zugrunde gelegt:***EN 60204-1:2018**Person authorised to compile the technical file:  
*Dokumentationsbevollmächtigter:*Koppen & Lethem Ltd  
3 Glenholm Park, Brunel Drive  
Newark | Nottinghamshire | NG24 2EG  
United Kingdom

Aschheim, 2022-08-05

  
Axel Schwerdtfeger, CTO  
Dogan Basöz, Product Manager