

Hydraulic Locking Unit (HLU) for Passenger Restraint Systems

Assembly instructions

Type:
ID no.:

System solution
HLU LE-X (M)



(Translation of the original instructions)

B 6052-21

09-2022 -1.9 en

HAWE
HYDRAULIK

© by HAWE Hydraulik SE.

The reproduction and distribution of this document, as well as the use and communication of its contents to others without explicit authorization, is prohibited.

Offenders will be held liable for the payment of damages.

All rights reserved in the event of patent or utility model applications.

Brand names, product names and trademarks are not specifically indicated. In particular with regard to registered and protected names and trademarks, usage is subject to legal provisions.

HAWE Hydraulik respects these legal provisions in all cases.

HAWE Hydraulik cannot provide individual guarantees that the stated circuits or procedures (including in part) are not subject to the intellectual property rights of third parties.

Printing date / document generated on: 27.09.2022

Table of Contents

| | | |
|----------|--|-----------|
| 1 | About these instructions..... | 5 |
| 1.1 | About these instructions..... | 5 |
| 1.2 | Target audience..... | 5 |
| 1.3 | Safety instructions and symbols..... | 6 |
| 1.4 | Applicable documents..... | 8 |
| 2 | For your safety..... | 9 |
| 2.1 | Intended use..... | 9 |
| 2.2 | Misuse..... | 9 |
| 2.3 | Residual risks..... | 10 |
| 2.4 | Duties of the operator..... | 10 |
| 2.5 | Qualification of the personnel..... | 11 |
| 2.6 | Personal protective equipment..... | 11 |
| 3 | About this product..... | 12 |
| 3.1 | Structure..... | 12 |
| 3.2 | Functions..... | 14 |
| 3.2.1 | Type EX: Blocking against extension..... | 15 |
| 3.2.2 | Type RE: Blocking against retraction..... | 15 |
| 3.2.3 | Type DL (EX): Blocking against extension with comfort lock..... | 16 |
| 3.2.4 | Type DL (RE): Blocking against retraction with comfort lock..... | 17 |
| 3.3 | Instructions for the ride manufacturer..... | 18 |
| 3.4 | Markings..... | 21 |
| 4 | Transport and storage..... | 22 |
| 4.1 | Transport equipment..... | 22 |
| 4.2 | Checking the delivery..... | 22 |
| 4.3 | Storage..... | 23 |
| 5 | Assembly and installation..... | 24 |
| 5.1 | Mechanical connection..... | 25 |
| 5.2 | Electrical connection..... | 27 |
| 6 | Start-up..... | 29 |
| 6.1 | Starting up the hydraulic locking unit..... | 29 |
| 7 | Operation..... | 30 |
| 7.1 | Switching on and off..... | 30 |
| 7.2 | Temporary shutdown..... | 31 |
| 7.3 | Response in emergency..... | 32 |
| 7.3.1 | Opening with power supply connected..... | 32 |
| 7.3.2 | Opening with power supply disconnected..... | 32 |
| 7.3.3 | Opening under high static load..... | 33 |

| | | |
|-----------|--|-----------|
| 8 | Maintenance..... | 36 |
| 8.1 | Maintenance plan..... | 38 |
| 8.2 | Cleaning and visual inspection for damage..... | 39 |
| 8.2.1 | Locking unit..... | 40 |
| 8.2.2 | Emergency override..... | 40 |
| 8.2.3 | Piston rod..... | 41 |
| 8.2.4 | Piston type accumulator..... | 41 |
| 8.2.5 | Check valves with cover..... | 42 |
| 8.3 | Mechanism..... | 43 |
| 8.3.1 | Check for leaks in the locking unit..... | 43 |
| 8.3.2 | Check function of emergency override button..... | 43 |
| 8.3.3 | Check rod end bolt connection..... | 44 |
| 8.3.4 | Check pivot bearing clearance..... | 45 |
| 8.3.5 | Replace pivot mounts..... | 46 |
| 8.3.5.1 | Rod-side rod end..... | 46 |
| 8.3.5.2 | Base-side rod end..... | 50 |
| 8.4 | Electrics..... | 53 |
| 8.4.1 | Check and replace coil..... | 53 |
| 8.5 | Filling the hydraulic accumulator..... | 55 |
| 8.6 | Functional check..... | 58 |
| 8.6.1 | Locking function..... | 58 |
| 8.6.2 | Opening function..... | 59 |
| 8.6.3 | Hold and drift function..... | 60 |
| 9 | Disassembly and disposal..... | 62 |
| 10 | Troubleshooting..... | 64 |
| 10.1 | Troubleshooting in the locking unit..... | 65 |
| 11 | Appendix..... | 67 |
| 11.1 | Technical data..... | 67 |
| 11.1.1 | Operating conditions..... | 67 |
| 11.1.2 | Weights and measures..... | 68 |
| 11.2 | Shipping data..... | 68 |
| 11.3 | System - parts list..... | 69 |

1 About these instructions

1.1 About these instructions

This manual is part of the product and describes the safe and proper use in all operating phases.

All photos and drawings in this manual show an available product variant. For precise details concerning the variant you have purchased, please refer to the type plate attached to the product.

-
-  ▶ Read instructions before use.
 - ▶ Make the manual accessible to operating and maintenance personnel at all times.
 - ▶ Keep this manual for the lifetime of the product.
 - ▶ Only pass on the product to third parties together with this manual.
-

Device specially designed for use at fairs and/or amusement parks

The product may only be put into operation by the fairground ride manufacturer once the higher-level system meets the requirements of DIN 13814, the Use of Work Equipment Directive 2009/104/EC, the Directive 89/391/EEC and the national regulations of the country of use.

The information in these instructions must be supplemented by the plant manufacturer in accordance with the results of his own risk assessment. The plant manufacturer must decide which information contained in these installation instructions is relevant for the operator of the plant and must pass on the information.

1.2 Target audience

The target audience of this manual is trained and qualified personnel who are familiar with the installation, operation and maintenance of machines.





The manual provides relevant information for the machine manufacturer and machine operator as well as for training courses.

To request further information about the product, contact HAWE Micro Fluid GmbH.

1.3 Safety instructions and symbols

Safety indication





In these instructions, the following warning and safety notes are used:

| Symbol | Meaning |
|---|--|
|  | Draws your attention to a hazardous situation that can directly lead to serious injury or death if not avoided. |
|  | Draws your attention to a hazardous situation that can indirectly lead to serious injury or death if not avoided. |
|  | Draws your attention to a hazardous situation that can indirectly lead to light to moderate injury if not avoided. |
|  | Notice to prevent environmental and material damage. |
|  | Information to ensure the correct use of the product. |

Safety symbols

| | | | |
|---|--|--|-----------------------------------|
|  | General safety symbol Draws your attention to additional safety information. | | |
|  | Slipping hazard |  | Dragging hazard from moving parts |
|  | Harmful substances |  | Tripping and falling hazard |
|  | Fire accelerants |  | Falling loads |
|  | Burn hazard |  | Crushing hazard |
|  | Electrical voltage |  | Suspended loads |
|  | No access to persons with pacemakers and defibrillators | | |

Mandatory signs

| Protective equipment | |
|---|--|
|  | <p>Safety boots Wear appropriate safety boots to protect your feet against mechanical hazards</p> |
|  | <p>Work gloves Wear suitable work gloves to protect your hands against chemical and mechanical hazards.</p> |
|  | <p>Safety goggles Wear safety goggles to protect your eyes against chemical and mechanical hazards.</p> |
|  | <p>Protective clothing</p> <ul style="list-style-type: none"> ▶ Wear fitted clothing without protruding parts. ▶ Follow the safety data sheet of the hydraulic fluid. |

1.4 Applicable documents

 The locking unit has been designed and manufactured in compliance with engineering practice according to the Pressure Equipment Directive (PED 2014/68/EU Article 4, paragraph 3), and is safe to use. No EU Declaration of Conformity may be issued for pressure equipment and assemblies classified in the Pressure Equipment Directive according to Article 4 (3). No CE mark may be affixed.

| Standards | Name |
|--------------|---|
| DIN EN 13814 | Fairground and amusement park machinery and structure - Safety of amusement rides and amusement devices |
| ASTM F2291 | Standard Practice for Design of Amusement Rides and Devices |
| F 698-94 | Standard Specification for Physical Information to be Provided for Amusement Rides and Devices |
| F 846-92 | Standard Guide for Testing Performance of Amusement Rides and Devices |
| F 893-10 | Standard Guide for Inspection of Amusement Rides and Devices |
| ISO 17842-01 | Safety of amusement rides and amusement devices -- Part 1: Design and manufacture |
| Documents | Designation |
| D 6052-21 | Data sheet: Characteristics and applications for this product |
| R 2020/16 | Information: HAWE Load Case Definition |

 **The documents listed here are available via the HAWE customer portal.**
Log in at: <https://customerportal.hawe.com/>. If you have any questions about usage, please contact your HAWE Sales Manager.

2 For your safety

The product is built according to the state of the art and recognized safety regulations.

Nevertheless, there is a risk of personal injury and damage to property if this chapter and the safety instructions in this manual are not observed.

2.1 Intended use

- The product is a technical work tool and intended for commercial and industrial use only.
- The product may only be operated in accordance with the technical data, operating conditions and performance limits specified in this manual.
- Only use original accessories and original spare parts approved by the manufacturer.

- The product may be used outdoors and indoors.
- The product is used for the infinitely variable locking of passenger restraint systems on seats in amusement rides and flying structures.
- Any rides that are operated as flying structures on the territory of the United States of America are excluded from said use.
- Forces may only be transmitted to the locking unit by way of articulated lugs.
- Use the product only after undergoing training by the seat or ride operator.

2.2 Misuse

- Use in other operating modes than specified in the intended use
- Using the product beyond the specified performance limits

- Do not convert the product or modify it in any way.
- Do not paint over elastic sealing parts, bearings of moving parts and hose lines.
- Do not use this product in potentially explosive atmospheres.

2.3 Residual risks

When handling hydraulic fluid, comply with the safety data sheet of the fluid's manufacturer.

DANGER



Risk to life due to explosive combustion

Hydraulic fluid, and its associated mists and vapors, is a fire accelerant. Contact with ignition sources will lead to explosive combustion. Risk of serious injury or death.

- ▶ Avoid fire, open flames, and smoking anywhere near the product.
- ▶ Immediately dispose of any flammable materials moistened with hydraulic fluid as hazardous waste.
- ▶ Do not use any flammable or corrosive cleaning agents.

WARNING



Electrical and magnetic fields

Electrical and magnetic fields impair the functionality of cardiac pacemakers and implanted defibrillators.

- ▶ People with pacemakers or implanted defibrillators must maintain a sufficient distance from magnets.
- ▶ Advise people with pacemakers or implanted defibrillators against approaching magnets.
- ▶ Cordon off the area around the drive system and affix suitable warning signs to the barriers.

WARNING



Risk of injury through crushing or cutting

Body parts might get trapped or severed between the machine frame and hydraulic system in the event of careless transport, installation and de-installation.

- ▶ Never reach between the hydraulic system and the machine frame.
- ▶ Ensure other people cannot enter the hazardous area.
- ▶ Wear gloves and appropriate footwear.

2.4 Duties of the operator

Observe and comply with regulations:

- ▶ The product must not be commissioned until the complete higher-level machine or system complies with the provisions, safety regulations and standards relevant in that country for the application.
- ▶ Observe and apply regulations for accident prevention and environmental protection.
- ▶ Assess and document any new dangers in the complete system's manual.

Operate product safely:

- ▶ Despite safety devices, the product still poses residual risks. Observe the safety instructions in this manual to reduce health hazards and avoid dangerous situations.
- ▶ The operating company must ensure the operating conditions (see the technical data) are within the limits for use of the product.
- ▶ Keep all instructions/signs on the product in legible condition and observe them.

Instruct personnel:

- ▶ Regularly train personnel in all points of these instructions and ensure they are observed.
- ▶ Ensure the terms of the industrial safety and operating instructions are observed.
- ▶ Only use qualified personnel. Due to their training and experience, qualified personnel must be able to recognize risks and avoid possible hazards.

2.5 Qualification of the personnel

The activities described in these instructions require basic knowledge of mechanics, hydraulics and electrics.

For the transport and handling of heavy loads, additional knowledge in handling hoists and slings is required.

- ▶ The activities may only be carried out by an appropriate specialist or an instructed person under the supervision of a specialist.
- ▶ Activities other than those described in these instructions may only be performed by HAWE or authorized specialist companies.
- ▶ The personnel must have read and understood these instructions.

Trained personnel

Personnel instructed comprehensively, by skilled staff on behalf of the owner, in how to perform their appointed tasks and in how to use the product safely.

Specialist personnel

Due to their technical training, knowledge and experience, specialists are able to assess and carry out the assigned work and can independently recognize possible dangers.

Qualified electrician

A person with appropriate professional training, knowledge and experience, so that he/she can recognize and avoid dangers that can be caused by electricity.

Auditor

Persons of a technical inspection body who are authorized to perform testing and monitoring tasks for pressure equipment and electrical systems.

2.6 Personal protective equipment

Personal protective equipment (PPE) is designed to prevent and reduce hazards.

In the instructions, safety instructions with mandatory symbols indicate the wearing of special protective equipment for special activities.

The supply of PPE, and instruction in its proper use, is carried out by the operator.

3 About this product

3.1 Structure

The hydraulic locking unit (HLU) (2) is a closed hydraulic system, including hydraulic fluid, for the infinitely variable locking of passenger restraint systems (1) on seats in amusement rides and flying structures.

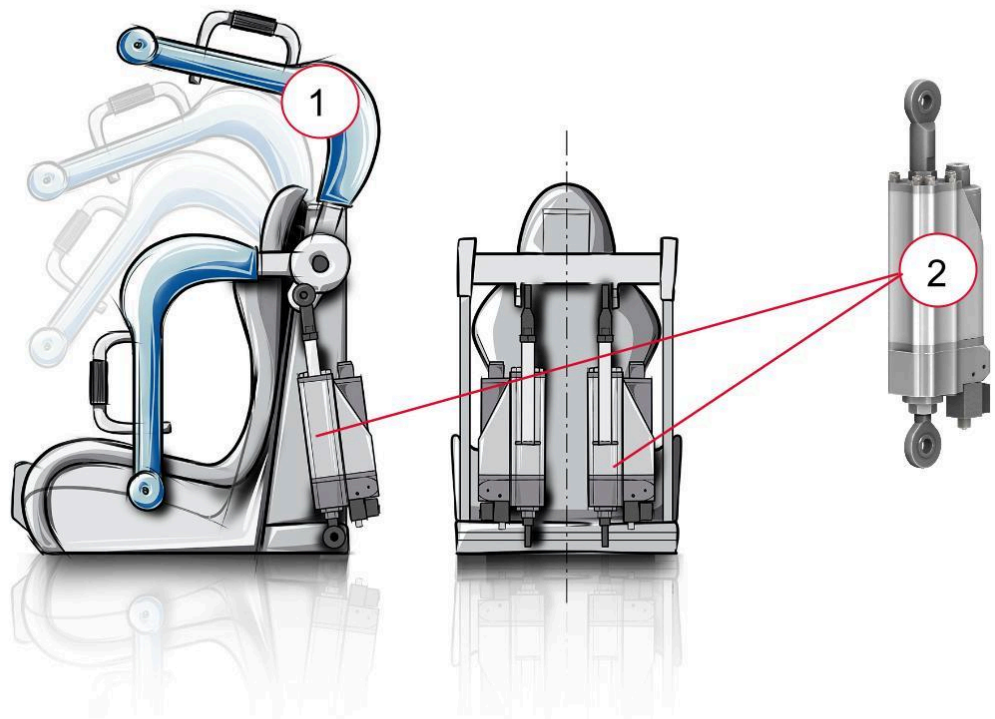

It is available in different sizes, which vary in cylinder stroke, direction of locking, extension forces, operating loads and maximum loads, and supplies pressure according to the technical data specifications.

The operating principle of the four standard versions type EX, type RE, type DL (EX), and type DL (RE) is described below.

i To protect them from environmental effects, the emergency override buttons feature rubber caps.

Design of type EX and type RE:

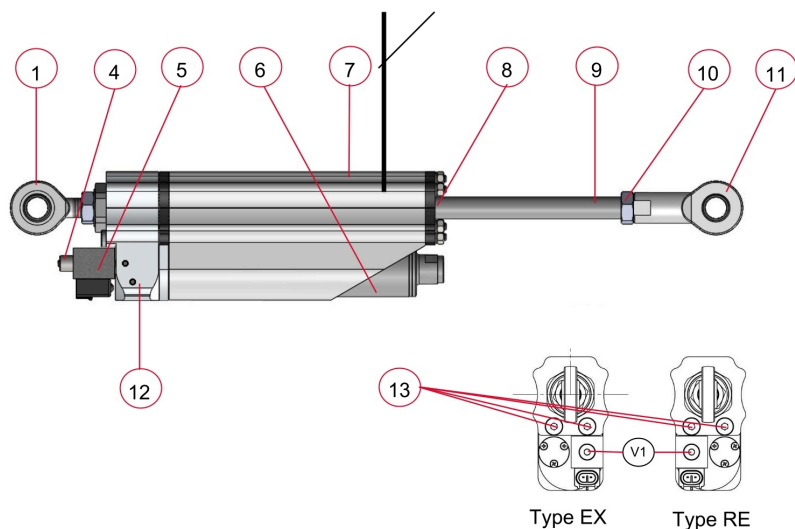

Design of type DL (EX) and type DL (RE)

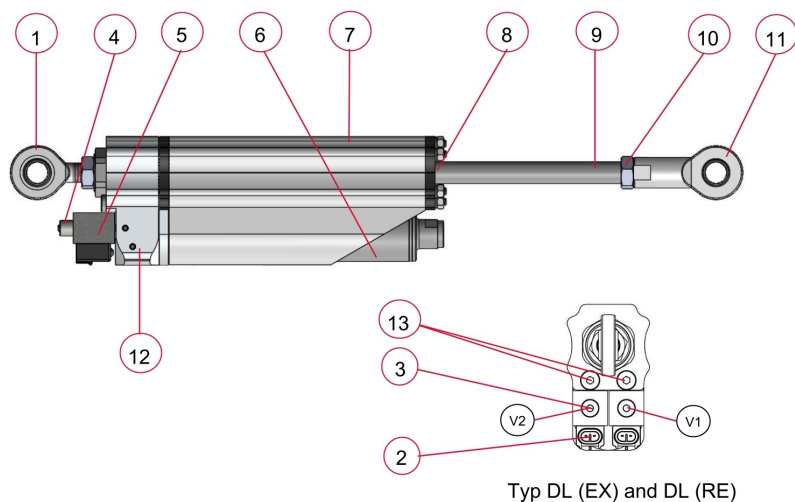

- | | | | |
|---|--|----|---|
| 1 | Rod end, base-side, with external thread | 8 | Wiper |
| 2 | V2 (only type DL): solenoid 2/2-way directional seated valve | 9 | Piston rod |
| 3 | Emergency override button V2 with rubber cap (only type DL) | 10 | Rod end lock nut |
| 4 | Emergency override button V1 with rubber cap | 11 | Rod end, bar side, with internal thread cap |
| 5 | V1 2/2-way directional seated valve with electromagnetically releasing check valve | 12 | Connection block |
| 6 | Piston type accumulator | 13 | Check valves with sealing caps |
| 7 | Double-acting cylinder | | |

3.2 Functions

The inner tube of the clamped double-acting cylinder guides the piston rod with the piston. The outer tube conveys the oil on the rod side to the flanged connection block on the cylinder base. The connection block holds the piston type accumulator, the electromechanically and manually releasing check valve, and two pressure ports. The piston type accumulator preloads the unit to a defined pressure, and captures the oil volume displaced by the piston rod when retracting. The piston type accumulator allows the locking unit's piston rod to extend at different speeds and forces depending on the pressure ratios.

The seated valve allows the flow of oil only in one direction; it blocks flow in the opposite direction. A flow of oil in both directions is possible through electromechanical actuation (3) and/or (4) in normal operation. In case of emergency, the valve (4) must also be actuated manually. The pressure connections are intended for filling oil at the plant and configuring the pressure of the unit, see "Structure", page 12 et seq.

⚠ WARNING**Danger to life if valves V1 and V2 are energized while running**

If valves V1 and V2 are energized while the ride is running, the restraint system might release and riders might suffer fatal injury.

- Keep valves V1 and V2 de-energized during operation.
 - Please note the switching logic on page 20.
-

3.2.1 Type EX: Blocking against extension

**Primary function:
Locking the restraint
system**

The hydraulic locking unit is connected via the rod ends (1) and (11) to the ride's restraint system (such as the shoulder bar mechanism), and can be unlocked manually/electrically. When the restraint system is closed, the piston rod (9) of the hydraulic cylinder (7) retracts, filling the hydraulic accumulator (6). This builds up and maintains a hydraulic pressure. The restraint system is closed.

The piston rod (9) is prevented from extending by the check valve (5). The restraint system is thus locked.

**Secondary function:
Opening the restraint
system**

The hydraulic locking unit acts as a bar drive. The piston rod (9) extends by extension force as soon as the 2/2-way valve (5) is energized and thereby opened. The hydraulic pressure is relieved, and the hydraulic locking unit's restraint system (such as the bar) is actively opened.

3.2.2 Type RE: Blocking against retraction

**Primary function:
Close and lock restraint
system**

The hydraulic locking unit is connected via the rod ends (1) and (11) to the ride's restraint system (such as the shoulder bar mechanism), and can be unlocked manually/electrically. When the restraint system is closed, the piston rod (9) of the hydraulic cylinder (7) is extended. The hydraulic pressure in the accumulator (6) is relieved, ensuring correct internal flow of hydraulic fluid. The restraint system is closed.

The piston rod (9) is prevented from retracting by the check valve (5). The restraint system is thus locked.

**Secondary function:
None**

The hydraulic locking unit type RE generates only low piston extension forces by design. When the 2/2-way valve (5) is energized, and thereby opened, the piston rod (9) of the hydraulic cylinder (7) remains extended. The piston rod can be moved in the retraction and extension directions.

It is not possible to drive the restraint system's opening motion by way of the hydraulic locking unit. The low extension forces produce a force that closes the restraint system. An additional system (such as a gas spring or leg spring) is therefore required to drive the opening motion and keep the restraint system (such as the bar) open.

3.2.3 Type DL (EX): Blocking against extension with comfort lock

The hydraulic locking unit is connected via the rod ends (1) and (11) to the ride's restraint system (such as the shoulder bar mechanism).

Comfort locking

When the restraint system is open, the double-sided locking of valve V2 (2) prevents the hydraulic cylinder (7) from retracting under load. Riders can use the restraint system as a handhold when entering and exiting the ride. Further closing of the restraint system too tightly is prevented while the ride is running. Both functions enhance rider comfort.

Closing the restraint system

When valve V2 (2) is energized, the restraint system can be closed. When the restraint system is closed, the piston rod (9) of the hydraulic cylinder (7) retracts, filling the hydraulic accumulator (6). A hydraulic pressure is built up and maintained in the process. The restraint system is closed.

The piston rod (9) is prevented from extending by the non-energized check valve V1 (5), and the restraint system cannot be opened.

Primary function: Locking the restraint system

When the restraint system has reached its end position, valve V2 (2) is de-energized. The piston rod (9) can neither retract nor extend. The restraint system is thus locked, and can be neither opened nor closed.

Secondary function: Opening the restraint system

The hydraulic locking unit acts as a bar drive. The piston rod (9) extends by extension force as soon as V1 (4) is energized and thereby opened. The hydraulic pressure is relieved, and the restraint system bar is actively opened.

3.2.4 Type DL (RE): Blocking against retraction with comfort lock

The hydraulic locking unit is connected via the rod ends (1) and (11) to the ride's restraint system (such as the shoulder bar mechanism).

Comfort locking

When the restraint system is open, the double-sided locking of valve V2 (2) prevents the hydraulic cylinder (7) from retracting under load. Riders can use the restraint system as a handhold when entering and exiting the ride. Further closing of the restraint system too tightly is prevented while the ride is running. Both functions enhance rider comfort.

Closing the restraint system

When valve V1 (5) is energized, the restraint system can be closed. When the restraint system is closed, the piston rod (9) of the hydraulic cylinder (7) is extended. The hydraulic pressure in the accumulator (6) is relieved, ensuring correct internal flow of hydraulic fluid.

The piston rod (9) is prevented from retracting by the non-energized check valve V2 (2), and the restraint system cannot be opened.

Primary function: Locking the restraint system

When the restraint system is closed, the piston rod (9) of the hydraulic cylinder (7) is extended and locked to stop it retracting. The hydraulic pressure in the accumulator (6) is relieved, and holds the piston rod in position hydraulically.

When the restraint system has reached its end position, valve V1 (5) is de-energized. The piston rod (9) can neither retract nor extend. The restraint system is thus locked, and can be neither opened nor closed.

Secondary function: Opening the restraint system

Type DL (RE) locking units always generate very low piston extension forces by design. When valves V1 (5) and V2 (2) are energized, and thereby opened, the piston rod (9) of the hydraulic cylinder (7) remains extended, and can only be retracted by an additional system.

It is not possible to drive the restraint system's opening motion by way of the locking unit. The low extension forces produce a force that closes the restraint system. An additional system (such as a gas spring or leg spring) is therefore required to drive the opening motion and keep the restraint system open.

3.3 Instructions for the ride manufacturer

-  All of the necessary safety equipment, safety functions and the safety controller should be provided by the machine manufacturer.

The following functions must be assured on the ride/machine, and supplemented with other measures according to your own risk assessment:

Personal safety

- Malfunctions on the ride can be safely remedied, and do not pose a risk to the hydraulic locking unit.
- The ride in which the hydraulic locking unit is installed fully complies with all legal requirements.
- A failure of the electrical power supply to the hydraulic locking unit does not pose any risk.
- A main switch and an emergency stop function are integrated into the ride, or in a higher-level control system.
- It is not possible for persons to reach into the hazard zone of the hydraulic locking unit.
- Persons cannot be endangered by movement of the restraint system.
- Persons cannot randomly or unintentionally open the restraint system/hydraulic locking unit.
- Persons cannot burn themselves on hot surfaces. After the hydraulic locking unit has been installed in the ride, place signs to identify hot surfaces that could endanger persons.

Construction and control

-  Maximum loads in drawings and product documentation are calculated according to DIN EN 13814. For locking units on seat classes* 4 and 5 a 70/30 load distribution was applied, and for locking units on seat class* 3 a direct load of 100%. The loads relate to the linear forces acting directly on the piston rod of the hydraulic locking unit.

If the restraint system is not safeguarded by redundancy, the maximum permissible holding forces must be recalculated. Get in touch with HAWE Micro Fluid GmbH.

* Seat classes defined in DIN EN 13814

Installation and control of the hydraulic locking unit is to be implemented by the ride manufacturer. The following supplementary functions and design measures should be added according to your own risk assessment, and must be integrated into the ride control system.

- The hydraulic locking unit must not be used as a mechanical end stop for the bar structure.
- Pay attention to the specific seat kinematics of the ride.
- The limits specified in the technical data sheets (especially the retraction and extension speeds) must not be exceeded.
- Observe the requirements of DIN EN 13814 and the HAWE Load Case Definition, see "R 2020/16", page 8.
- Protect the hydraulic locking unit against harmful environmental effects resulting from the construction of the ride or seat, such as very salty water, water containing chemical additives, or other caustic and corrosive liquids.
- Note that if type RE is installed, an opening aid (such as a gas spring or leg spring) is required to drive the opening motion and to keep the restraint system open.
- Note that if type DL (EX) is installed the necessary holding forces and leak-proofing for locking in the locking direction (primary function) are assured solely by valve V1.
- Note that if type DL (RE) is installed the necessary holding forces and leak-proofing for locking in the locking direction (primary function) are assured solely by valve V2.
- Monitor the emergency override button on (V1) and (V2) so that the lock cannot be released unintentionally.
- The control system must ensure that the 2/2-way valve is prevented from being energized, and thereby opening, while the ride is running.
- Please note the switching logic on page 20.
 - V2 for type DL (EX) is only intended for comfort locking.
 - V1 for type DL (RE) is only intended for comfort locking.

- If more than one hydraulic locking unit is installed per restraint system, the valves of all the relevant locking units must be actuated when the restraint is opened.
- If the emergency override is used, overriding of all relevant locking units must be initiated simultaneously.

Operating modes

- The ride manufacturer must specify the modes for safe operation of the hydraulic locking unit within the ride.

Aids and tools

Provide the following aids, tools and materials:

- Mobile battery unit to open the hydraulic locking unit without power supply.
- Note the type-specific design of the auxiliary tool to operate the button(s) (3 and 4) of the 2/2-way valve (= emergency override). The accessories listed below are listed in the technical data sheet, [see "D 6052-21", page 8.](#)



Type EX/ RE

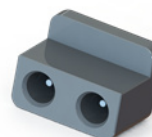

Type DL (EX and RE)

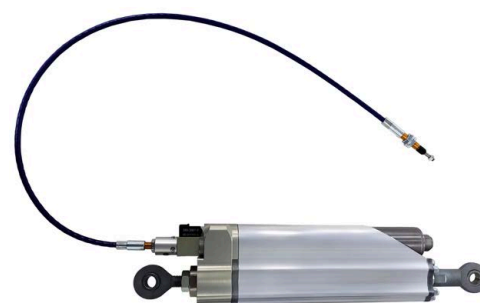

Remote unlocking set

Function sequences

Integrate the following switching logic in your ride control system.

| Type | | V1 | V2 |
|---------|--|----|----|
| EX | Retract piston rod | 0 | - |
| | Close and lock restraint system | 0 | - |
| | Extend piston rod | 1 | - |
| | Opening the restraint system | 1 | - |
| RE | Extend piston rod | 0 | - |
| | Close and lock restraint system | 0 | - |
| | Retract piston rod* *Additional retraction system required (such as a gas spring) | 1 | - |
| | Opening the restraint system | 1 | - |
| DL (EX) | Retract piston rod | 0 | 1 |
| | Restraint system can be closed | 0 | 1 |
| | Extend piston rod, piston rod movable in both directions | 1 | 1 |
| | Opening the restraint system | 1 | 1 |
| | Restraint system locked - for ride - for entry and exit assist when using the comfort function | 0 | 0 |
| DL (RE) | Extend piston rod | 1 | 0 |
| | Restraint system can be closed | 1 | 0 |
| | Extend piston rod, piston rod movable in both directions | 1 | 1 |
| | Opening the restraint system | 1 | 1 |
| | Restraint system locked - for ride - for entry and exit assist when using the comfort function | 0 | 0 |

* For startup and service

3.4 Markings

(1) Engraved type identifier

The type identifier is engraved on the valve block of the hydraulic locking unit. The type identifier shows the following information:

- Item number (86X-XXXX-X)
- 1050 Test passed (T)
- Serial number (ZZZZ)
- Date of manufacture (year.month.day)
- Pressure P2 in bar

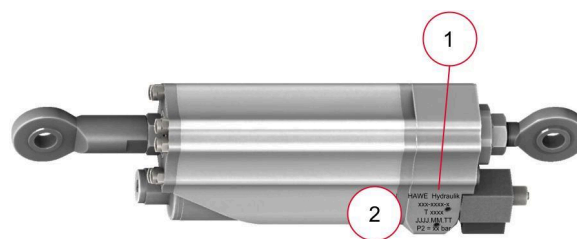

(2) Data matrix code

The data matrix code is located on the side of the cylinder. The following information is encrypted in the data matrix code:

- Item number
- Order number
- Serial number
- Date of production
- Pressure P2 in bar

In addition to the safety instructions presented in Section [For your safety](#) follow the safety instructions below.

⚠ CAUTION**Personal injury through tipping or falling load**

The product might tip over or fall during transport. This could lead to hands and feet becoming trapped.

- ▶ Adhere to the symbols on the packaging.
- ▶ Use permitted transport aids to carefully transport the product as close to the installation location as possible.
- ▶ Select transport aids that will allow the maximum load to be transported safely.
- ▶ Wear safety shoes, work gloves and safety glasses.

⚠ WARNING**Danger to life due to negligence when transporting the hydraulic locking unit**

Damage to the gas valves on preloaded pressure vessels, or to the pressure vessels themselves, can cause hydraulic fluid or nitrogen to escape at high pressure and penetrate deep into the body via the skin and eyes. This can lead to severe and irreparable injury, or even death.

- ▶ Transport to be carried out only by instructed personnel.
- ▶ Do not subject gas valves to any load.
- ▶ Avoid shock impact on the gas valve.

4.1 Transport equipment

Only tested and approved aids may be used.

! NOTICE**Preventing damage in transit**

- ▶ Remove the hydraulic locking units individually from the packaging.
- ▶ Do not subject gas valves to any load.
- ▶ Protect gas valves for shipping by padding.

4.2 Checking the delivery**Scope of delivery**

- Assembled hydraulic locking unit filled with hydraulic fluid, with a double-acting cylinder and a piston type accumulator preloaded with nitrogen

Supplied separately by email

- Assembly instructions
- Product specific technical data sheet
- Product specific technical drawings

Not included

- Aid for assembling the rod ends on the base side
- Tool to actuate the emergency release

- Fastening pins and bushings
- Electrical cables

Unpacking

1. Remove each hydraulic locking unit from the package separately:
 - Hold by the rod ends.
2. Remove the packaging without scratching the piston rods.
3. Check the hydraulic locking unit for completeness and transport damage:
 - If you discover damage, refuse the delivery or accept it with reservation.
 - Note the transport damage on the transport documents or on the forwarder's delivery note.



4. Dispose of the hydraulic locking unit's packaging in a manner that complies with local regulations.

! NOTICE

For any defect found, file a complaint immediately with:

HAWE Micro Fluid GmbH
Borsigstraße 11
93092 Barbing, Germany
Tel.: +49 89 379100-6000

Claims for damages can only be addressed within the applicable complaint periods. HAWE does not accept any liability for subsequent complaints.

4.3 Storage

! NOTICE

Property damage from incorrect storage

Incorrect storage can lead to damage. Refer to the technical data.

Store the locking unit and its individual components as follows:

- In disassembled state: Store only with the piston rod extended by 5 to 10 mm.
- In installed state: Do not lock the restraint system against the locking direction.
- Store in a dry and dust-free place.
- Protect from sunlight (UV radiation) and corrosion (such as very salty water).
- Protect from mechanical damage and damp.
- Do not store near ignition and heat sources.
- Note all additional specifications by the ride manufacturer.

In addition to the safety instructions presented in Section [For your safety](#) follow the safety instructions below.

 **Startup means initial commissioning and subsequent startups.**

DANGER

Danger to life due to damage to the pressure vessel

Damaged pressure vessels can cause hydraulic fluid or gas to escape at high pressure and penetrate deep into the body via the skin and eyes. This can lead to severe and irreparable injury, or even death.

- ▶ Assembly only by trained specialist personnel.
- ▶ Never weld, solder or drill pressure accumulators.
- ▶ Do not disconnect the pressure accumulator from the hydraulic locking unit.
- ▶ Never modify the hydraulic locking unit with pressure accumulator.
- ▶ Never perform any maintenance on the hydraulic accumulator yourself.

WARNING

Danger of crushing/malfunction from unexpected startup

Body parts may be crushed or shorn off if the system starts up unexpectedly.



- ▶ Wear protective clothing.
- ▶ Take precautions to prevent anyone from entering the danger zone throughout all commissioning or maintenance work.
- ▶ Do not energize solenoid valves while uninstalled.
- ▶ Do not trigger emergency release while uninstalled.

CAUTION

Risk of tripping and falling

Insufficient space for performing the necessary jobs on the hydraulic system increases the risk of accidents due to tripping or falling.



- ▶ Provide a ladder or access platform to make sure the workspace can be reached safely.
- ▶ Ensure there is sufficient space to perform all assembly and installation work.
- ▶ Do not climb onto the hydraulic system.

CAUTION

Risk of falling from leaking hydraulic fluid

Spilled or leaked hydraulic fluid can form a slippery film on the floor.



- ▶ Use suitable aids when filling or bleeding.
- ▶ Check all connecting elements that convey oil for leaks before switching on the motor in the parent system.
- ▶ Wipe up leaked hydraulic fluid with suitable aids.

! NOTICE**Material damage due to mechanical damage**

Protect the product against mechanical damage, e.g. by applying suitable padding.

- ▶ such as foam, covers, cardboard

5.1 Mechanical connection**⚠ WARNING****Lethal danger/malfunction from incorrectly installed hydraulic locking unit**

Incorrectly installed hydraulic locking units or use of unsuitable line cross sections and connectors can cause malfunctions, accidents, and irreversible or even fatal injuries.

- ▶ Wear protective clothing.
- ▶ Install the locking unit only in the manner and position specified.
- ▶ Make adjustments to the angle to match the seat's design on the base-side rod end only!
- ▶ Do not adjust the angle as a means to change the length.
- ▶ Keep all drilling chips, screws, and other foreign objects out of the ring gap between piston rod and cylinder head.
- ▶ Protect the piston rod from damage to its surface.
- ▶ Only trained specialist personnel is permitted to assemble the hydraulic locking unit.

! NOTICE**Property damage from incorrectly installed hydraulic system**

- ▶ Assembly by trained specialists only.
- ▶ Ensure all labels and markings of the hydraulic system are easily visible and legible after assembly.
- ▶ Check installation space/connection points for damage.

1. Space required for assembly, installation and startup:
500x400x500 mm (WxHxD).
2. Transport the hydraulic locking unit safely to the installation site.
3. Make sure that the locking unit is not touching the seat structure or other ride components when extended or retracted, or in any other position during operation.
 - ▶ The connection may only be made by the mounting points (ball joint).
4. Note the diameters of the rod eyes and rod ends:
 - ▶ Rod eye diameter in rod end 15: $\varnothing 15_{-0.008\text{mm}}$
 - ▶ Rod eye diameter in rod end 17: $\varnothing 17_{-0.008\text{mm}}$

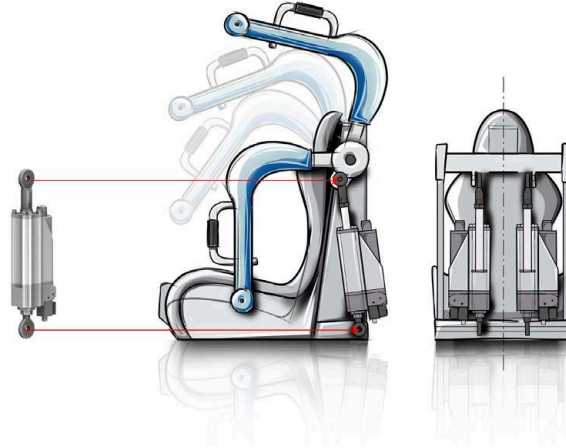

5. Note the maximum permissible tilt angle α on the ball joint:
 - ▶ Rod end 15: up to 4.5°
 - ▶ Rod end 17: up to 5.5°
6. Check the tilt angle setting in the following operating states:
 - ▶ Restraint system open
 - ▶ Restraint system closed
 - ▶ Restraint system in mid-way position
7. Fasten the locking unit to the restraint system via the ball joint (1) using pins (2).

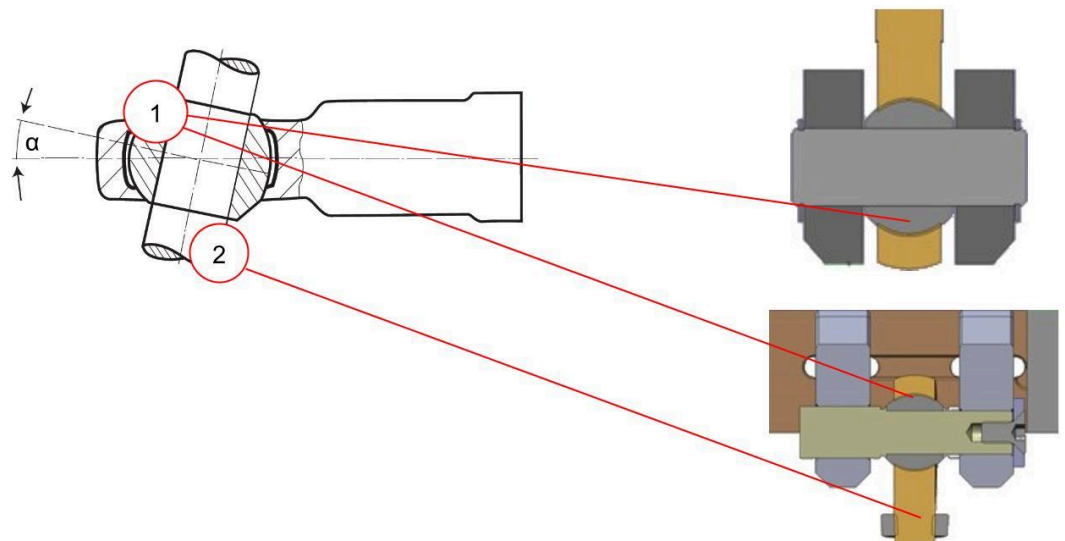

8. Make adjustments to the angle to match the seat's design on the base-side rod end only!
 - ✓ Do not pivot the rod end by more than 180° compared with the as-delivered position.
 - ✓ The angle has not been changed to adjust the length, because that is not permitted.
 - ✓ For specified torques and anti-twist protection (such as threadlocker) refer to the technical drawing.
 - ✓ The hydraulic locking unit must not be used as a mechanical end stop for the bar structure. Otherwise, suitable precautions are required (e.g. rubber buffers/stops in the seat kinematics).
9. Make sure that unintentional emergency overriding is always prevented if you install additional release mechanisms.

5.2 Electrical connection

NOTICE

Damage from kinked or crushed power cables

Kinked or crushed power cables may cause wires to sever and cables to catch fire.

- ▶ Never kink or crush cables.

WARNING

Electrical and magnetic fields

Electrical and magnetic fields impair the functionality of cardiac pacemakers and implanted defibrillators.



- ▶ People with pacemakers or implanted defibrillators must maintain a sufficient distance from magnets.
- ▶ Advise people with pacemakers or implanted defibrillators against approaching magnets.
- ▶ Cordon off the area around the drive system and affix suitable warning signs to the barriers.

WARNING

Danger due to signal interference at check valve

The electromagnetically actuated check valve of the hydraulic locking unit can be subject to interference from electrical, magnetic and electromagnetic fields in the surrounding environment. Signals cannot be transmitted correctly as a result. This can lead to hazardous situations, and danger to life.

- ▶ Lay power and signal cables so that they do not affect the check valve.
- ▶ Use only cables designed for the specific application type (fixed, flexible or highly flexible; outdoor).
- ▶ Follow the cable manufacturer's instructions for selecting the cable type.
- ▶ Include all metal components of the ride in the equipotential bonding plan.

! NOTICE**Hazard for electronic components – property damage**

Electromagnetic waves lead to malfunctions of electrical or electronic equipment.

- ▶ To prevent electrostatic discharge, do not touch electronic components or contacts.
- ▶ After switching off the electrical power supply, wait at least 15 minutes for the energy stored in the capacitors to dissipate.
- ▶ Do not expose components to moisture or an aggressive environment.
- ▶ To avoid overheating, always keep ventilation openings (if any) open to allow sufficient air circulation.

1. Secure the ride against unintentional starting.
2. Connect the solenoid valves to the control system:
 - ▶ The coil has a socket for 2-pin plugs.
 - ▶ Use cable with a matching plug according to the technical data sheet.
 - ▶ Pin assignment is not important
 - ▶ Plug the cable plug into the coil's socket.
 - ▶ Then connect cable to the electrical power supply.
3. Check whether the HLU has any more solenoid valves that require connecting and connect them as instructed in step 2.
4. Check electrical connection after one week of operation.

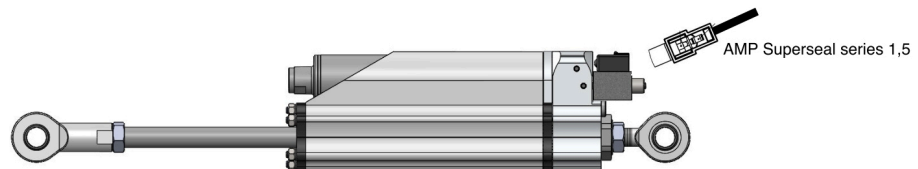

6 Start-up

6.1 Starting up the hydraulic locking unit

⚠ CAUTION



Burn hazard from hot surfaces and hydraulic fluid

A burn hazard results from directly or indirectly coming into contact with hot hydraulic fluid and hot components of the hydraulic system.

- ▶ Wear work gloves.
- ▶ Arrange the access to the hydraulic system in such a way that hot surfaces are not accessible to the user.
- ▶ Wait until the hydraulic system has cooled down before servicing or disassembling it.

1. Start-up may only be carried out by specialist personnel.
2. Secure the ride against unintentional starting.
3. Check the hydraulic locking unit for damage, see "[Cleaning and visual inspection for damage](#)", page 39.
4. Check that the hydraulic locking unit has been properly connected as follows:
 - a) **Mechanical:**
 - ✓ Has the hydraulic locking unit been prevented from being used as a mechanical limiter for the bar structure?
 - ✓ Has the hydraulic locking unit been installed free of mechanical stress, and is it protected against the action of lateral forces?
 - ✓ Is the locking unit not touching the seat structure when extended and retracted, and when in any position during operation?
 - ✓ Are all signs and markings clearly visible?
 - ✓ Check all mechanical joints as described in the chapter on maintenance, see "[Mechanism](#)", page 43.
 - b) **Electrical:**
 - ✓ Check the connection to the central control system and the cable connections on the hydraulic locking unit.
5. Switch on the control system's power supply.
6. Check the valve switching and function sequencing according to the switching logic on page 20.
7. Check the locking and opening function, see "[Functional check](#)", page 58 et seq.
8. Check bolt connections after one week of operation at the latest.

⚠ DANGER**Danger to life due to faulty or outdated locking unit**

Using a faulty hydraulic locking unit, or one that has been operated beyond its specified service life, can lead to malfunctions in operation, and accidents entailing danger to life.

- ▶ Assembly only by trained specialist personnel.
- ▶ Do not use the hydraulic locking unit if ice has formed on the piston rod, as this will damage the wiper.

Replace the hydraulic locking unit if:

- ▶ the restraint system no longer opens fully.
- ▶ the restraint system can no longer be closed.
- ▶ the restraint system's play exceeds the permissible maximum when closed.
- ▶ the useful life as per the technical data (operating conditions) has expired.

⚠ CAUTION**Burn hazard from hot surfaces and hydraulic fluid**

A burn hazard results from directly or indirectly coming into contact with hot hydraulic fluid and hot components of the hydraulic system.

- ▶ Wear work gloves.
- ▶ Arrange the access to the hydraulic system in such a way that hot surfaces are not accessible to the user.
- ▶ Wait until the hydraulic system has cooled down before servicing or disassembling it.

7.1 Switching on and off

The hydraulic locking unit is supplied with power, opened and locked via the ride's control system. When opening the HLU or actuating the valve coil, no external force must act in the locking direction. The coil will otherwise not be able to switch against the hydraulic pressure.

ⓘ NOTICE

Negligent startup procedures will result in malfunctions and accidents during operation of the hydraulic locking unit.

- ▶ Startup to be carried out only by trained specialist personnel.
- ▶ Secure the ride against being unintentionally switched on.
- ▶ Clean the emergency override before every startup.
- ▶ Carry out startup procedures properly.
- ▶ Before each time commissioning, but not before each ride, check all mechanical connections as per "Mechanism", page 43.
- ▶ If the hydraulic locking unit has been removed before re-commissioning, also perform the steps as per "Start-up", page 29.

Daily before starting rides

1. Check the mechanical connections according to the maintenance schedule.
2. Check locking, opening and holding function as well as the drift as per "Functional check", page 58 et seq. and maintenance plan.

7.2 Temporary shutdown

NOTICE

Damage due to incorrect piston position during temporary shutdown

If the hydraulic locking unit is shut down temporarily (overnight or longer) with the piston in an incorrect position, temperature fluctuations can damage the unit. Pressure differences cannot be balanced.

During temporary standstills, ensure the following:

- ▶ The locking unit is unlocked.
- ▶ It is possible to move the restraint system at least 10 to 15 mm in the locked direction.
- ▶ The restraint system is not at the mechanical end position of the bar structure.

1. Make sure the piston rod is in the correct position.
2. Switch off the hydraulic locking unit in the ride control system.
3. Secure the unit against use by unauthorized persons.
4. Ensure correct storage, [page 23](#).

7.3 Response in emergency

In the event of emergencies and malfunctions, the ride manufacturer or operator as appropriate must decide between:

- ▶ Opening with power supply connected
- ▶ Opening with power supply disconnected
- ▶ Opening under high static load

WARNING

Risk of injury in event of inadequate qualification

Improper operation of the emergency override can result in severe injury and damage to property.

- ▶ The emergency override may only be operated by trained personnel or instructed persons.
- ▶ After the emergency override has been operated, the locking, opening and holding function, as well as the drift, must be checked as per the functional check procedure.



The ride operator is responsible for ensuring that passengers are able to disembark, e.g. in the event of evacuation.

7.3.1 Opening with power supply connected

1. Make sure that all ride passengers are secured against falling after unlocking.
2. Make sure that the locking unit is being supplied with power.
3. Energize check valve V1, and on type DL locking units additionally energize valve V2.
 - ✓ The restraint system is open.
4. Make sure that all ride passengers can disembark safely.
5. Check locking, opening, and holding functions in accordance with "Functional check", page 58 et seq.

7.3.2 Opening with power supply disconnected

NOTICE

Damage due to incorrect operation of the emergency override

The locking unit's emergency override might be destroyed by incorrect operation.

- ▶ Operate the emergency override only using a suitable tool as described under "Instructions for the ride manufacturer".
- ▶ Avoid using sharp-edged and pointed tools.
- ▶ Push the emergency override button in the middle (no radial or lateral loading).
- ▶ Make sure that connected actuating mechanisms contact on the middle of the button.
- ▶ Only depress the buttons far enough for the check valves (V1 or V1 and V2) to open and the piston rod to become freely movable. There is a noticeable resistance when the button is pushed.

1. Make sure that all ride passengers are secured against falling before unlocking.
2. Make sure there is no one within the opening radius of the restraint bar.
3. Open the locking unit:

- ▶ using the portable battery unit
 - ▶ or with the button for emergency actuation of the check valves (V1 or V1 and V2) using a suitable auxiliary tool on page 19.
 - remove rubber cap if no remote unlocking set is installed
 - only press buttons so far until the check valves (V1) open
 - ▶ or open the locking unit as instructed under "Opening under high static load."
4. Make sure that all ride passengers can disembark safely.
 5. Check locking, opening, and holding functions in accordance with "Functional check", page 58 et seq.
 6. Put the rubber cap back on the emergency override if no remote unlocking set is installed.

7.3.3 Opening under high static load

Freeing a trapped person

1. Make sure that all ride passengers are secured against falling after unlocking.
2. Make sure there is no one within the opening radius of the restraint bar.
3. Perform the following three actions in sequence to free the trapped person:
 - a) Action 1: Press in closing direction
 - b) Action 2: Unscrew rod-side rod ends
 - c) Action 3: Remove check valve

Action 1: Press in closing direction

Aids, tools, materials

- Power supply or portable battery unit
1. Briefly push the bar firmly in the closing direction and at the same time energize the unlocking valves according to the switching logic set out in the "Function sequences" chapter.

or:
 2. If there is no power, operate the emergency override and at the same time briefly push the bar firmly in the closing direction.
 3. Make sure that all ride passengers can disembark safely.
 4. Check locking, opening, and holding functions in accordance with "Functional check", page 58 et seq.
 5. If the restraint system does not open, proceed with action 2.

Action 2: Unscrew rod-side rod ends**Aids, tools, materials**

- See instructions for replacing rod ends in "Replace pivot mounts", page 46
1. Open the rod-side rod ends using an open-end wrench while holding the nut in place with another wrench.
 - Rod end: wrench size 22
 - Nut: wrench size 24
 2. Unscrew the rod ends from the piston rod.
 - ✓ The restraint system is no longer locked.
 3. Make sure that all ride passengers can disembark safely.
 4. Clean and inspect the hydraulic locking unit in accordance with the maintenance measures.
 - ▶ The locking unit has been prepared for use again. Replace the rod ends as instructed in this manual.
 - ▶ Permission to continue use of the hydraulic locking unit has not been unequivocally granted or there are still doubts. Get in touch with HAWE Micro Fluid GmbH.
 5. Check locking, opening and holding function as per "Functional check", page 58 et seq. after the hydraulic locking unit is connected.

Action 3: Remove check valve

Draining the hydraulic fluid will depressurize the hydraulic locking unit, and the restraint system can be opened.



This is an irreversible action. The hydraulic locking unit must then be replaced.

- ▶ Carry out the following actions only if unlocking the hydraulic locking unit is not possible either by connecting power or by pushing the emergency override button or by dismantling the rod-side rod ends.

⚠ DANGER**Danger to life from pressurized systems**

When lines and components on pressurized systems are disconnected, hydraulic fluid escapes at high pressure and penetrates deep into the body via the skin and eyes. Severe injury or death.

- ▶ Depressurize the hydraulic system including the pressure tank.
- ▶ Secure the hydraulic system against unintentional restart.
- ▶ Check components for correct assembly before pressure is applied.
- ▶ Observe maximum pressure load for fittings and lines.

**⚠ CAUTION****Risk of falling from leaking hydraulic fluid**

Spilled or leaked hydraulic fluid can form a slippery film on the floor.

- ▶ Use suitable aids when filling or bleeding.
- ▶ Check all connecting elements that convey oil for leaks before switching on the motor in the parent system.
- ▶ Wipe up leaked hydraulic fluid with suitable aids.

**Aids, tools, materials**

- M8 hex key
- M10 hex key

1. Drain the hydraulic fluid as follows:
 - a) Prepare an oil receptacle (> 0.4 l).
 - b) Unscrew tapped plugs (13), see "Structure", page 12 et seq.
 - c) Unscrew check valves (13), see "Structure", page 12 et seq.
 - ✓ The hydraulic fluid drains.
 - ✓ Hydraulic fluid has drained completely.
2. Open the restraint system.
3. Make sure that all ride passengers can disembark safely.
4. Clean any areas contaminated by hydraulic fluid immediately.
5. Replace the hydraulic locking unit. Get in touch with HAWE Micro Fluid GmbH.
6. Dispose of hydraulic fluid, the hydraulic fluid container and any cleaning cloths contaminated with hydraulic fluid in the correct manner.

Maintenance measures consist of inspection, service and repair. Maintenance measures are described here.

- ▶ Maintenance work must only be carried out by qualified personnel.
- ▶ Tasks not described in this chapter may only be carried out by HAWE Service.
- ▶ If faults or damage occur, switch off the hydraulic system immediately.
- ▶ Observe the information in the supplier documentation.
- ▶ Document all activities in a maintenance log.

⚠ WARNING**Danger of accident and fatal injury due to lack of maintenance or careless maintenance**

Omitted or negligently performed maintenance can cause the hydraulic system to malfunction. Improperly performed maintenance or improperly conducted troubleshooting can pose a danger to personnel.

- ▶ Read and abide by all instructions provided in this section.

In addition to the safety instructions presented in Section [For your safety](#) follow the safety instructions below.

- Contact HAWE Micro Fluid GmbH immediately if you are in doubt as to whether or not the locking unit can be reused after the maintenance procedure. The locking units should not be used again until clarification has been obtained.
- Only use genuine spare parts.

⚠ WARNING**Risk of fatal injury from electric shock**

Touching live components directly or indirectly causes injury or death.



- ▶ Electrical and electronic components must only be replaced and connected by trained specialist personnel.
- ▶ Obey all applicable electrical safety rules.
- ▶ Only connect electric lines to the hydraulic system while the system is de-energized.

⚠ DANGER**Danger to life from pressurized systems**

When lines and components on pressurized systems are disconnected, hydraulic fluid escapes at high pressure and penetrates deep into the body via the skin and eyes. Severe injury or death.



- ▶ Depressurize the hydraulic system including the pressure tank.
- ▶ Secure the hydraulic system against unintentional restart.
- ▶ Check components for correct assembly before pressure is applied.
- ▶ Observe maximum pressure load for fittings and lines.

⚠ WARNING**Danger of accident and fatal injury due to lack of maintenance or careless maintenance**

Omitted or negligently performed maintenance can cause the hydraulic system to malfunction. Improperly performed maintenance or improperly conducted troubleshooting can pose a danger to personnel.

- ▶ Read and abide by all instructions provided in this section.
- ▶ After troubleshooting, follow the instructions in the assembly instructions for (initial) and (re)commissioning.

⚠ WARNING**Danger of crushing/malfunction from unexpected startup**

Body parts may be crushed or shorn off if the system starts up unexpectedly.



- ▶ Wear protective clothing.
- ▶ Take precautions to prevent anyone from entering the danger zone throughout all commissioning or maintenance work.
- ▶ Do not energize solenoid valves while uninstalled.
- ▶ Do not trigger emergency release while uninstalled.

⚠ CAUTION**Burn hazard from hot surfaces and hydraulic fluid**

A burn hazard results from directly or indirectly coming into contact with hot hydraulic fluid and hot components of the hydraulic system.



- ▶ Wear work gloves.
- ▶ Arrange the access to the hydraulic system in such a way that hot surfaces are not accessible to the user.
- ▶ Wait until the hydraulic system has cooled down before servicing or disassembling it.

⚠ CAUTION**Risk of falling from leaking hydraulic fluid**

Spilled or leaked hydraulic fluid can form a slippery film on the floor.



- ▶ Use suitable aids when filling or bleeding.
- ▶ Check all connecting elements that convey oil for leaks before switching on the motor in the parent system.
- ▶ Wipe up leaked hydraulic fluid with suitable aids.

8.1 Maintenance plan

Failure of hydraulic systems

Hydraulic system failures are often caused by an incorrect choice of hydraulic fluid or excessive solid contamination in the hydraulic fluid. High solid contamination is due to lack of maintenance of the hydraulic system.

- ▶ Select hydraulic fluid according to specifications.
- ▶ Carry out the activities described in this section carefully and in due time.

| | HAWE inspection interval | Ride manufacturer's inspection interval |
|--|--------------------------|---|
| Cleaning and visual inspection for damage | | |
| Locking unit | | ✓ |
| Emergency override | | ✓ |
| Piston rod | | ✓ |
| Piston type accumulator | | ✓ |
| Tapped plug on check valve (droplet formation) | | ✓ |

Mechanism

| | | |
|--|--|---|
| Check locking unit for external leakage | Part of the daily functional check, page 43. | |
| Check emergency override button and clean if necessary | | ✓ |
| Check rod-side and base-side rod end bolt connection, retighten if necessary, then renew/apply paint marking. The rod end must be screwed all the way in. | | ✓ |
| Check pivot bearing clearance | Weekly | |
| Replace rod ends | | ✓ |

Function testing

| | | |
|-------------------------------------|--------------------------------|--|
| Function testing: locking | Daily and before every startup | |
| Function testing: opening | Daily and before every startup | |
| Function testing: holding and drift | Weekly | |

Load distribution on the locking systems

Note the effects of the mutual check on the load distribution of the locking units, see "Functional check", page 58.

Electrics

| | |
|--|------------------------|
| Check electrical contacts (AMP Superseal series 1,5) | In case of malfunction |
| Check solenoid, replace if necessary | In case of malfunction |

8.2 Cleaning and visual inspection for damage

 **Visual changes are possible with corrosion protection level C4M.**
This is not a defect.

NOTICE

Damage due to incorrect cleaning

Use of incorrect cleaning agents will damage the piston rod and the seals, resulting in leakage.

Observe the following points when cleaning the hydraulic locking unit:

- ▶ Clean only with a damp non-fluffing cloth.
- ▶ Do not use cleaning wool or the like.
- ▶ Never use brake cleaner and universal thinner to clean stuck-on labels and markings.
- ▶ Sharp, angular or pointed implements must not be used for cleaning.
- ▶ Make sure that the piston rod is not scratched.
- ▶ Do not use high-pressure cleaners.
- ▶ Never spray the electronics/electronics cover with water (e.g. using a garden hose, high-pressure cleaner)
- ▶ Use only the care and cleaning products listed below.

Care and cleaning products

Corrosion and rust protection

| | |
|-------------------------------|---|
| Corrosion and rust protection | BRANOTect; Ballistol Spray ProTec |
| Preservative for storage | Bubble wrap, oiled paper or film wrap (protecting against mechanical damage and damp) |

Greases/oils/lubricants

| | |
|----------------------|------------------------|
| Multi-purpose grease | Castrol Tribol GR 2 EP |
| Oils/lubricants | WD-40 |

Cleaning products

| | |
|-------------------|---|
| Universal thinner | Staufen (Remondis Medison GmbH) |
| Brake cleaner | Keller & Kalmbach GmbH (Art. # 616715) |

Degreaser

| | |
|----------------------------------|--------------------------------------|
| to clean the pivot mount threads | LOCTITE 7063; Dupont Prepclean 3608S |
|----------------------------------|--------------------------------------|

Other

| | |
|------------------------|---|
| Threadlocking adhesive | LOCTITE 243 |
| Threadlocker | Standard commercial products |
| Hydraulic fluid | AVIA Fluid RSL 22 |
| Non-fluffing cloth | Clean cloth with high cellulose and low binder content, e.g. with itex® Soft WIP. |

Other

| | |
|---|--|
| Brass brush (Use only to clean thread when replacing pivot mount.) | Brass wire hand brush (crimped 0.25 mm) |
|---|--|

8.2.1 Locking unit

Maintenance intervals

Inspection interval specified by ride manufacturer.

It must be ensured that any damage, such as chipping or scratches and associated corrosion, is reliably detected. None of the above irregularities must be present, particularly on the sliding surface of the piston rod.

Aids, tools, materials

- Listed cleaning and care products

1. Extend piston rod
2. Shut down hydraulic locking unit and secure it against inadvertent restarting.
3. Remove any component coverings that obstruct checking.
4. Check and clean piston rod, wiper and rod ends.
5. Afterward, use the care products listed below to protect the locking unit.
6. The locking unit must be replaced if damaged. Get in touch with HAWE Micro Fluid GmbH.

8.2.2 Emergency override

⚠ WARNING

Risk of injury in event of inadequate qualification

Improper operation of the emergency override can result in severe injury and damage to property.

- ▶ The emergency override may only be operated by trained personnel or instructed persons.
- ▶ After the emergency override has been operated, the locking, opening and holding function, as well as the drift, must be checked as per the functional check procedure.

Maintenance intervals

Inspection interval specified by ride manufacturer.

It must be ensured that any damage to the pressure tube and actuating button which leads to a functional failure of the emergency release is reliably detected. The area around the button must always be kept clean to prevent dirt from entering the valve. The emergency override valve is better protected against environmental effects when fitted with a rubber cap, and cleaning it is then also much easier.

Aids, tools, materials

- Type-specific version of the auxiliary tool for triggering emergency actuation on page 19.
- Listed cleaning and care products

1. Shut down hydraulic locking unit while it is unlocked (depressurized) and secure it against inadvertent restarting.
 - ✓ Type EX/type DL (EX): Piston rod extended
 - ✓ Type RE/DL (RE): Piston rod retracted
2. Remove any component coverings that obstruct checking.
3. Remove the rubber cap if no remote unlocking set is installed.
4. Clean the area around the emergency override button with brake cleaner. Stubborn stains can be removed with a cloth soaked in universal thinner.
5. After waiting about two minutes for the cleaner to act, press the emergency override button again five times.
 - ▶ Use suitable tools.

6. Repeat the last two steps until the emergency override button resets smoothly and with virtually no friction.
 - ▶ Replace the locking unit if the emergency override button is no longer moving smoothly.
 - ▶ Get in touch with HAWE Micro Fluid GmbH.
7. When you have finished, clean the area around the emergency override button with brake cleaner several times.
8. Put the rubber cap back in place if no remote unlocking set is installed.
9. Recommission hydraulic locking unit in the system, see "Start-up", page 29.

8.2.3 Piston rod

Maintenance intervals

Inspection interval specified by ride manufacturer.

It must be ensured that damage to the piston rod, such as scratches, chipping, or dents in the surface, as well as corrosion, is reliably detected. None of the above irregularities must be present, particularly on the sliding surface of the piston rod.

Aids, tools, materials

- Listed cleaning and care products

1. Extend piston rod
2. Shut down hydraulic locking unit and secure it against inadvertent restarting.
3. Remove any component coverings that obstruct checking.
4. Check and clean piston rod.
5. Afterward, use the care products listed below to protect the locking unit.
6. Recommission hydraulic locking unit in the system, see "Start-up", page 29.
7. The locking unit must be replaced if damaged. Get in touch with HAWE Micro Fluid GmbH.

8.2.4 Piston type accumulator

Maintenance intervals

Inspection interval specified by ride manufacturer.

It must be ensured that any damage, such as chipping or scratches and associated corrosion, is reliably detected.

Aids, tools, materials

- Listed cleaning and care products

1. Clean the piston type accumulator on the outside.
2. If there is any corrosion, use the care products listed below to protect the locking unit.
3. The locking unit must be replaced if damaged. Get in touch with HAWE Micro Fluid GmbH.

8.2.5 Check valves with cover

Maintenance interval

Check interval is defined by the system manufacturer.

The covers must never be removed. Each cover must be checked for leakage of hydraulic fluid. It must be ensured that any damage, such as spalling or scratches and the accompanying corrosion, are identified reliably.

Aids, tools, materials

- Listed cleaning and care agents

1. Clean tapped plug from the outside.
2. In the event of corrosion, use listed care agents to protect the hydraulic locking unit.
3. In the event of damage or leakage of hydraulic fluid on one of the covers, the hydraulic locking unit must be replaced. Contact HAWE Micro Fluid GmbH.

8.3 Mechanism

Corrosion and mechanical damage will result in leaks in the hydraulic system.

- ▶ Check the hydraulic locking unit periodically for mechanical damage and corrosion.
- ▶ The inspection intervals must be defined by the manufacturer/operator on the basis of a risk assessment. If damage is prevented by coverings and preventive corrosion protection, inspection can be scheduled at correspondingly long intervals. Otherwise short inspection intervals should be scheduled.

8.3.1 Check for leaks in the locking unit

Maintenance intervals

Daily

The daily check of the locking function also includes checking the locking unit for leaks.

Aids, tools, materials

- None

1. Test the following functions in the order given to check for leaks:
 - a) Test locking.
 - b) Test opening.
 - c) Test holding.
2. If you discover leaks during function testing, replace the locking unit. Get in touch with HAWE Micro Fluid GmbH.

8.3.2 Check function of emergency override button

WARNING

Risk of injury in event of inadequate qualification

Improper operation of the emergency override can result in severe injury and damage to property.

- ▶ The emergency override may only be operated by trained personnel or instructed persons.
- ▶ After the emergency override has been operated, the locking, opening and holding function, as well as the drift, must be checked as per the functional check procedure.

Maintenance intervals

Inspection interval specified by ride manufacturer.

Aids, tools, materials

- Type-specific version of the auxiliary tool for triggering emergency actuation on page 19.
- Listed cleaning and care products

1. Shut down hydraulic locking unit and secure it against inadvertent restarting.
2. Clean area around the emergency actuation button according to instructions in "[Emergency override](#)", page 40.
3. Switch on hydraulic locking unit and establish hydraulic pressure as noted in the table Function sequences on page 20 .
 - Type EX/type DL (EX): Retract piston rod
 - Type RE/DL (RE): Extend piston rod
4. Trip emergency override and check whether the piston rod extends/retracts.
 - ▶ If the piston rod fails to move, work through the troubleshooting catalog.
 - ▶ If it works, recommission hydraulic locking unit in the system, see "[Start-up](#)", page 29.

8.3.3 Check rod end bolt connection

Maintenance intervals

Inspection interval specified by ride manufacturer.

⚠ WARNING

Injury due to negligent checking of the rod end bolt connection Negligent checking of the rod end bolt connection can lead to failure of the hydraulic locking unit, and to fatal accidents during operation.

- ▶ Check the paint markings between the rod end and piston rod, and the rod end and connection block, according to the maintenance plan.
- ▶ Decommission the hydraulic locking unit if the paint markings are damaged between the rod end and piston rod or rod end and connection block.

Rod-side rod end

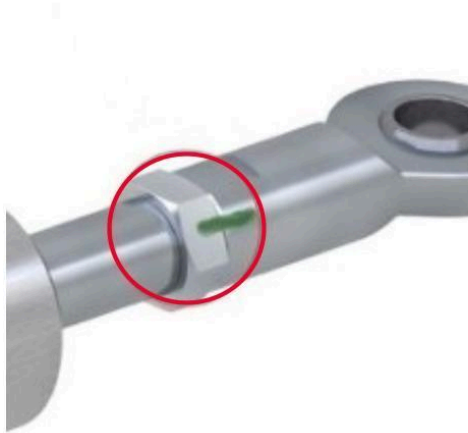

Base-side rod end



Aids, tools, materials

- See instructions for replacing rod ends in chapter 7.4.5.
1. Shut down hydraulic locking unit and secure it against inadvertent restarting.
 2. Remove any component coverings that obstruct checking.
 3. Visually inspect the indicated locations.
 4. If the paint marking is damaged or rod ends / nuts should become loosened: immediately shut down hydraulic locking unit. Then perform the steps in "[Rod-side rod end](#)", page 46 or "[Base-side rod end](#)", page 50.

8.3.4 Check pivot bearing clearance

Maintenance intervals

Weekly

Aids, tools, materials

- Measuring systems for checking the pivot bearing clearance (e.g. feeler gage)

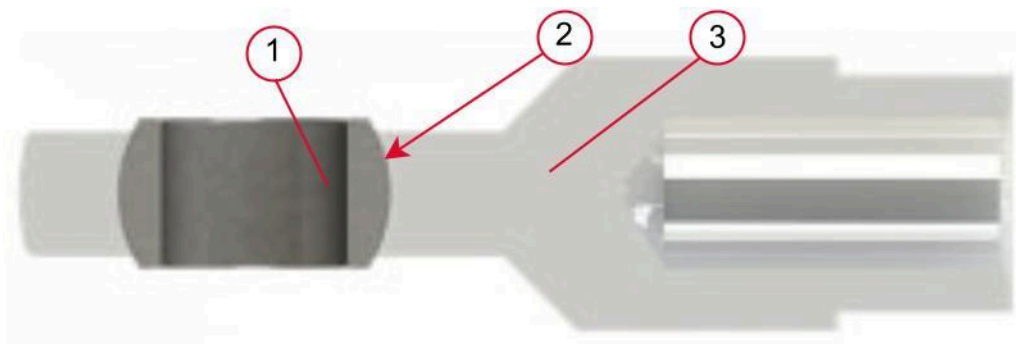

1. The ball joints (1) of the hydraulic locking unit must be freely accessible.
 - ▶ Shut down hydraulic locking unit and secure it against inadvertent restarting.
 - ▶ Remove any component coverings that obstruct checking.
2. Apply an alternating radial force to the ball joint (1).
 - ▶ Measure the rod end bearing gap between the ball joint (1) and bearing case (2).
3. Replace the rod end (3) if gap between the ball joint (1) and the bearing case (2) exceeds 0.2 mm.
 - ✓ HAWE-approved pivot mount used.
 - ✓ Rod end replaced in accordance with "[Replace pivot mounts](#)", page 46.

8.3.5 Replace pivot mounts

 Pivot mounts are wearing parts which are subject to load-dependent wear. Unless otherwise separately agreed, the pivot mounts are factory-sealed with threadlocking adhesive.

NOTICE

Damage due to incorrect procedure when replacing pivot mounts

- ▶ Replacement to be carried out only by trained specialist personnel.
- ▶ Make sure that the connection block and piston rod are protected against damage.

Maintenance intervals

Inspection interval specified by ride manufacturer.

8.3.5.1 Rod-side rod end



CAUTION

Caution: hot surfaces

The rod ends must be heated to 200°C for disassembly.

- ▶ Rod ends must be freely accessible.
- ▶ Wear protective gloves.

Aids, tools, materials

- Replacement rod end according to the technical data specifications
 - Hot air gun
 - When replacing on a HLU-LE-X (M):
 - Open-end wrench, sizes 22 and 24 mm
 - Torque wrench with fork size 24 mm
 - Torques according to technical drawing
 - Degreaser, threadlocking adhesive, brass brush and lint-free cloth according to the recommended cleaning and care products on page 39.
1. Shut down hydraulic locking unit and secure it against inadvertent restarting.
 2. Remove the hydraulic locking unit from the ride.
 3. Clamp the hydraulic locking unit in a vise so that the rod end is easily accessible.
 - ▶ Use jaw caps.
 - ▶ Be careful not to damage the connection block.

4. Remove the red rubber cap to gain access to the emergency override mechanism. If the remote unlocking set is installed, this step is not necessary.



5. Fully extend the piston rod (2) by tripping the emergency override (1).

- ▶ Observe procedure from "Opening with power supply disconnected", page 32.

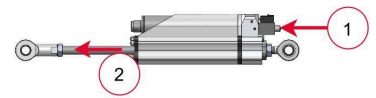

6. Heat the marked area (1) of the rod end to 200°C with a hot air gun (2).

- ▶ The threadlocker loses its adhesive properties.

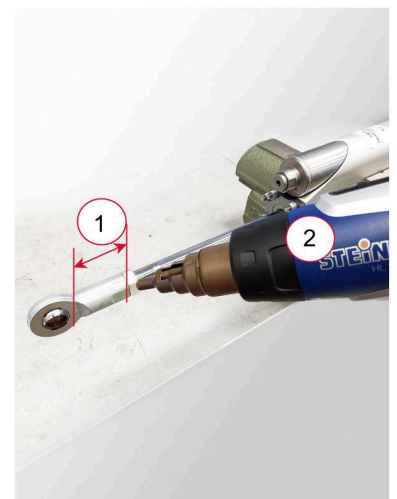

7. Open the heated rod end using the wrenches. Wrench size 22 (1); wrench size 24 (2)



8. Unscrew the rod end from the piston rod so that the nut stays on the piston rod.



9. Clean the thread with a brass brush all the way to the nut and degrease it.
 - a) When using the brass brush, make sure that no particles fall into the gap between the piston rod and seal.
 - b) Cover the area.
 - c) Clean the piston rod.



10. Apply threadlocking adhesive to the new rod end's internal thread.
 - ▶ Spread a visible amount of the adhesive onto the first thread turns.
 - ▶ Fill at least one turn of the internal thread with adhesive.



11. Screw the rod end onto the thread of the piston rod as far as it will go.



12. Using the open-end wrench (2) and torque wrench (1), tighten the rod end to the required torque according to the technical drawing.
Wrench size 22 (2); wrench size 24 (1)

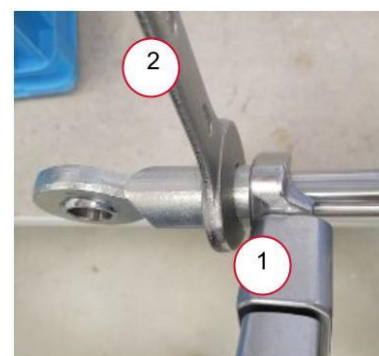

13. After tightening to torque, mark the nut and rod eye with threadlocker paint.
14. After 24 hours of curing time, the hydraulic locking unit can be used again and recommissioned in the system, see "Start-up", page 29.



8.3.5.2 Base-side rod end

Aids, tools, materials

- Replacement rod end according to the technical data specifications
- In case of replacement on a HLU unit:
 - Open-end wrench, wrench size 22 and 24 mm
 - Torque wrench with fork size 24 mm
 - Tap M 16
 - Torques as per technical drawing
- Degreaser, threadlocking adhesive, brass brush and lint-free cloth as per the recommended cleaning and care agents on page 39.
- Gap checker according to technical data

! NOTICE

Damage due to heat-up of the foot-side pivot mounts

Heating-up of the foot-side pivot mounts will damage seals and cause leaks in the hydraulic system.

- ▶ Never heat the base-side rod ends.
- ▶ Use the listed open-end wrenches to unscrew the rod ends.

-
1. Shut down hydraulic locking unit and secure it against inadvertent restarting.
 2. Remove the hydraulic locking unit from the ride.
 3. Clamp the hydraulic locking unit in a vise so that the rod end is easily accessible.
 - ▶ Use jaw caps.
 - ▶ Be careful not to damage the connection block.
 4. Open the rod end using a size 24 open-end wrench.



5. Use the wrench to screw the rod end off the cylinder base.



6. Carefully clean adhesive residues and dirt from the internal thread of the cylinder base with the tap (M 16).

- ▶ Do not damage the thread!



7. Blow off the cylinder base's thread with compressed air.

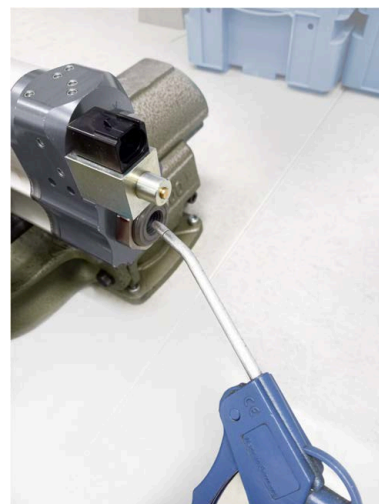

8. The gradation in the nut thread faces

- ▶ toward the piston rod on the rod-side rod end
- ▶ toward the base on the base-side rod end

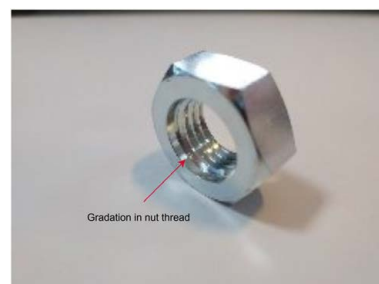

9. Apply threadlocking adhesive to the cylinder base's internal thread.
- ▶ Spread a visible amount of the adhesive onto the first thread turns.
 - ▶ Fill at least one turn of the internal thread with adhesive.



10. Screw the rod end with nut into the thread of the cylinder base.
- ▶ Comply with the minimum screw travel $L(1)$ in the customer drawing.

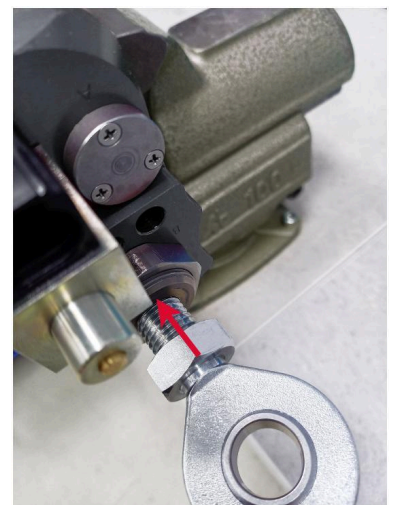

11. Apply threadlocking adhesive to the rod end's thread.
- ▶ Spread on an easily visible amount of adhesive 3 mm from the base.
 - ▶ Fill at least one turn of the thread with adhesive.



12. Use a torque wrench (size 24) to screw the nut all the way to the stop and tighten it to the torque specified in the technical drawing.
 - ▶ Use pliers to stop the rod end turning while doing so.



13. Mark the nut and rod eye with threadlocker paint.



14. After 24 hours of curing time, the hydraulic locking unit can be used again and recommissioned in the system, see "Start-up", page 29.

8.4 Electrics

8.4.1 Check and replace coil

Maintenance intervals

Only if there are malfunctions

Aids, tools, materials

- New coil as per technical data sheet
- Multimeter
- 2 small size 4 screwdrivers to remove housing
- Plastic hammer
- Assembly aid: Plastic ring or tube with 14 mm inner diameter and 24 mm outer diameter; length min. 30 mm

1. Shut down hydraulic locking unit and secure it against inadvertent restarting.
2. Remove component coverings.
3. Disconnect the cables from the solenoid valve coils.
4. Measure the resistances on the coils one after the other with the multimeter.

- ▶ Specified resistance: 26 ohms, permissible deviation ± 6 ohms
 - ▶ If the deviation is more, the coil is faulty and must be replaced.
5. Simultaneously insert the two screwdrivers into the gap between the connection block (1) and the solenoid housing (2). Carefully and evenly push the solenoid housing off the pressure tube.

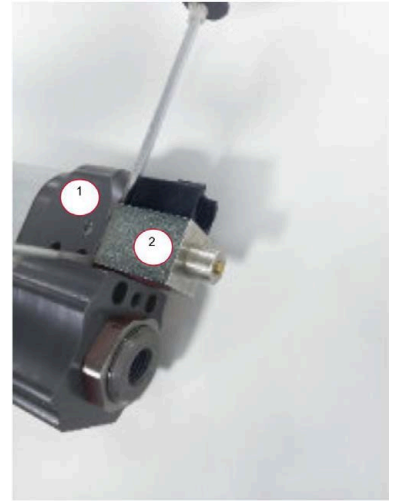

6. The pressure tube (1) is exposed. Take the coils (2) out of the solenoid housing (3).
7. Center and slide the new coil onto the pressure tube.
8. Push the solenoid housing over the coil and pressure tube so that the slot in the solenoid housing is pushed over the lower part of the coil. Push on the solenoid housing until it engages.

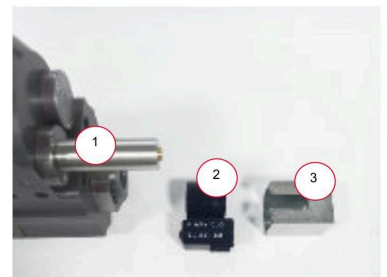

9. Place the assembly aid (1) on the solenoid housing (2) and carefully fix the solenoid housing in place by lightly tapping the assembly aid with the plastic hammer.



10. Check that the gap between the connection block (1) and the solenoid housing (2) is 0.5 to 1 mm, and is the same all around.
11. Repeat step 9 if the gap between the connection block and the solenoid housing is too big.
12. Connect the cable to the solenoid valve coils.

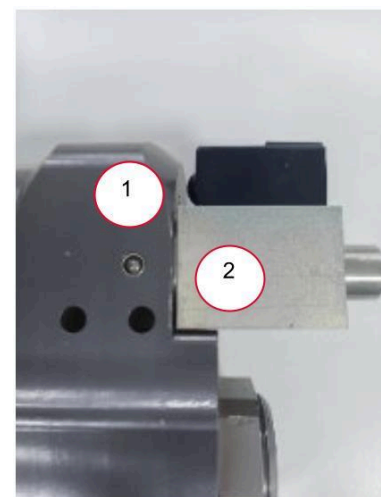

13. Activate the solenoid valves to check that they are working properly.
14. Recommission hydraulic locking unit in the system, see "Start-up", page 29.

8.5 Filling the hydraulic accumulator

i Topping up the hydraulic accumulator is only necessary if there is a malfunction. If you need to top it up more than once a year, the hydraulic locking unit is defective and must be replaced.

⚠ DANGER

The product will explode if used or filled incorrectly.

Serious injury or death.

- ▶ The accumulator of the product must be suitable for the maximum operating pressure, filling pressure and temperature range of the operating conditions.
- ▶ Only use suitable filling and testing devices.

Aids, tools, materials

- Hex key 8 AF and 6 AF
- Combination wrench 10 mm
- AMP Superseals connector (refer to technical data sheet for order number)
- HAWE DFM 400 filling device (order number in the technical data sheet).
- Adapter with HAWE ports M16 x 1.5 and M28 x 1.5 (refer to technical data sheet for order number)
- Nitrogen N2

Preparations

1. Shut down hydraulic locking unit and secure it against inadvertent restarting.
2. Remove any component coverings that obstruct checking.
3. Extend piston rod:

- ✓ coil (1) with switchable 24 VDC power supply and AMP Superseals connector is energized.
- ✓ Piston rod (2) fully extended.



AMP Superseal series 1,5

4. Remove 24 VDC electric power supply as well as AMP Superseal plug from the hydraulic locking unit.
 5. Using the combination wrench 10 mm, replace the mounted toggle of the filling device with the enclosed red handwheel.
- ✓ The toggle washer is no longer required for the handwheel and can be omitted.

Nitrogen supply

1. Connect nitrogen controller to your nitrogen bottle.
2. Make sure that the discharge throttles (2) on the controller are shut.
3. Open the nitrogen bottle's valve (1).
4. Set the nitrogen controller to the pressure P1 of your locking unit in accordance with the technical data sheet.
5. Watch the pressure on the nitrogen controller's pressure gage (3).

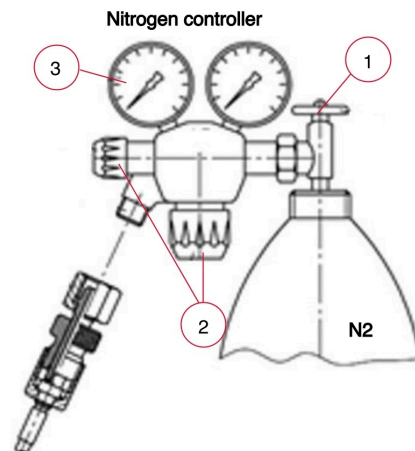

Connect accumulator

1. Screw off the accumulator's tapped plug (1) with a size 8 hex key.
2. Screw adapter (3) onto accumulator (4).
3. Open the filler screw (2) with a size 6 hex key. (1/2 turn)

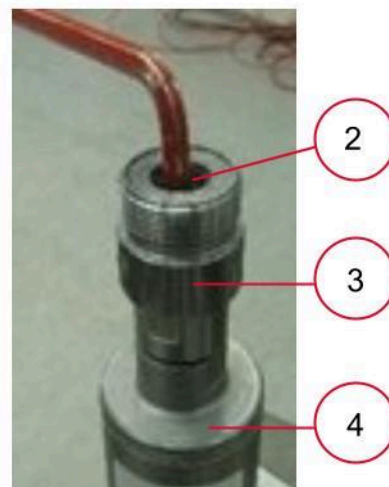

4. Screw HAWE DFM 400 filling device to the adapter.

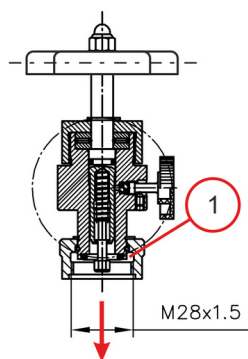

- ▶ Make sure that the filling unit has an O-ring.
- ▶ Lay the O-ring into the guide slot (1).
- ▶ Screw the filling unit's union nut (2) onto the adapter by hand.

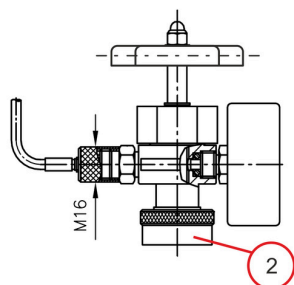

Fill

1. Connect the nitrogen controller to the filling unit with a hose.
2. Close drain valve (2).
3. Turn handwheel of the filling device (1) back and forth until the hex socket of the filling device (3) engages in the filling screw.
- ✓ Piston rod fully extended
4. Slowly release the filling screw anti-clockwise using the handwheel so that gas can flow.
5. Slowly open the nitrogen controller's discharge throttles.
6. Check pressure P1 on the pressure gauge of the filling device and adjust it. - Observe one minute of settling time.
7. Stop filling when P1 has been reached in the hydraulic accumulator.

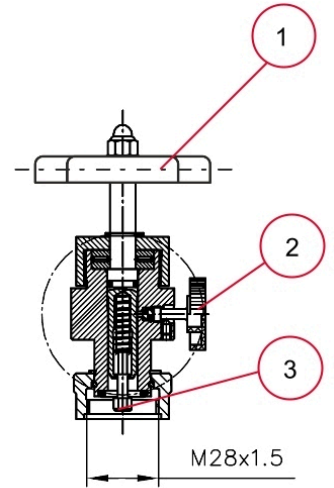

After filling

1. Close filling screw using handwheel.
2. Shut discharge throttle on nitrogen controller.
3. Slowly open drain valve.
4. Disconnect filling unit from adapter.
5. Close the filler screw with a size 6 hex key.
(see technical drawing for torque)
6. Disconnect adapter from hydraulic accumulator.
7. Screw on the accumulator's tapped plug with a size 8 hex key. (see technical drawing for torque)

8.6 Functional check

It must be ensured that valves switch reliably and are tight over the valve seat when closed, and that leaks are reliably detected. The fill pressure and accumulator preload pressure must also be monitored regularly.

i Load distribution to the locking systems with mutual testing

When testing for leaks by switching the valve coils alternately in a redundant system, the load can be unequally distributed by up to 70:30. One HLU bears 70% of the force introduced and the other HLU 30%.

- ▶ Both valves must be blocked after the mutual check.
- ▶ The unequal distribution described can then be corrected by a renewed closing movement of the restraint bar ("push in").
- ▶ Note unequal load distribution when planning and calculating the load.

8.6.1 Locking function

Interval

Daily

Aids, tools, materials

- Distance measuring systems (e.g. caliper gage, etc.)
- Tool to remove any component covering

-  To check the locking function, the locking unit is loaded with 10 to 20% of the permissible dynamic locking force in the opening direction for 3 to 5 seconds.
- Friction losses and lever forces of the seat kinematics (transmission ratios) must be taken into account when converting the force to be applied to the restraint system.
- If during the check the 'locked' position on the cylinder changes by more than 1 mm, or if oil leaks out, the locking unit is faulty, and must be replaced.

1. Always check only one locking unit at a time (alternating checks).
 - a) Shut off all other locking units and any mechanical back-up systems and secure them all against inadvertent restarting.
 - b) Make sure that no external force is acting on the locking unit, so that the check valve can open under load.
 - c) Restraint system closed as per the switching logic on page 20 .
2. Load the locking unit with 10 to 20% of the permissible **dynamic locking force** according to the technical data sheet for 3 to 5 seconds in the opening direction.
3. Pay attention to the position of the piston rod before and after applying the load.
 - ✓ Component coverings that obstruct checking have been removed.
 - ▶ If component coverings cannot be removed, determine the transmission ratio of the piston rod movement as a check indicator. To do this, calculate by how many millimeters the restraint system can be adjusted with 1 mm extension/retraction of the piston rod, Take into account the seat kinematics and bar ratio.
 - ▶ Take into account any permissible play in the restraint system mechanism.
 - ▶ If during the check the lock position on the cylinder changes by more than 1 mm in the locking direction, or if oil leaks out, the locking unit is faulty.
 - ▶ Replace the locking unit if it is faulty.

8.6.2 Opening function

DANGER

Danger to life due to damage to the pressure vessel

Damaged pressure vessels can cause hydraulic fluid or gas to escape at high pressure and penetrate deep into the body via the skin and eyes. This can lead to severe and irreparable injury, or even death.

- ▶ Assembly only by trained specialist personnel.
- ▶ Never weld, solder or drill pressure accumulators.
- ▶ Do not disconnect the pressure accumulator from the hydraulic locking unit.
- ▶ Never modify the hydraulic locking unit with pressure accumulator.
- ▶ Never perform any maintenance on the hydraulic accumulator yourself.

Interval

Daily

Aids, tools, materials

- None

-  Do not carry out checks in an extreme temperature range (see technical data sheet).

1. Restraint system closed as per the switching logic on page 20.
2. Opening of the restraint system as per the switching logic on page 20.
3. Do not continue to use the system in the event the following cases occur and note information in "Troubleshooting", page 64 et seq.:
 - ▶ Type EX and type DL (EX): The restraint system is no longer being opened far enough by the extension force of the locking unit.
 - ▶ Type RE/DL (RE): Check the accumulator pressure by a slack test: Extend the restraint system at the maximum permissible piston rod extension speed specified in the data sheet. There must be no slack.
4. Notify HAWE Micro Fluid GmbH Service.
5. Replace the locking unit if it is faulty.

8.6.3 Hold and drift function

Interval

Weekly

Aids, tools, materials

- Tool to adjust the restraint system
- Distance measuring systems (e.g. caliper gage, etc.)
- Tool to remove any component covering



To check the holding function, the locking unit must be loaded with at least 25% of the permissible static holding force in the restraint system's opening direction for at least 5 minutes.

- The higher the force and the longer the test lasts, the more resilient the result will be. HAWE specification: 1.5 mm / 30 min.
 - If during the check the lock position on the cylinder changes by more than 1.5 mm in the locking direction, or if oil leaks out, the locking unit is faulty, and must be replaced.
1. Always check only one locking unit at a time (alternating checks).
 - ▶ Shut off all other locking units and any mechanical back-up systems and secure them all against inadvertent restarting.
 - ▶ Make sure that no external force is acting on the locking unit. Otherwise the counter-pressure might prevent the check valve from opening.
 - ▶ Restraint system closed as per the switching logic page 20.
 2. Adjust the restraint system using the adjuster tool.
 - ▶ At the start of the load check ensure that the permissible play of the restraint system as well as potential elastic influencing factors (e.g. bar and seat padding) are balanced or compensated for and the measurement is therefore not distorted.
 3. Load the locking unit with at least 25% of the permissible **static holding force** according to the technical data sheet for a minimum of 5 minutes.
 4. Pay attention to the position of the piston rod before and after applying the load.
 - ▶ Remove any component coverings that obstruct checking.
 - ▶ Take into account any permissible play in the restraint system mechanism.

- ▶ If during the check the lock position on the cylinder changes by more than 1.5 mm in the locking direction, or if oil leaks out, the locking unit is faulty.
 - ▶ If any component coverings cannot be removed, determine the relative movement of the piston rod as an inspection indicator. In addition, calculate by how many mm the restraint system can be adjusted with 1 mm extension/retraction of the piston rod. Take into account seat kinematics and bar relationship.
5. Replace the locking unit if it is faulty.

-  On request, HAWE Micro Fluid GmbH can offer you the following service in fulfillment of product monitoring obligations under Section 31 of Germany's Product Liability Act:
- ▶ Take back, dismantle and dispose of single units (< 10) free of charge at the end of their lifetime. HAWE Micro Fluid GmbH will provide matching shipping boxes free of charge for shipping to HAWE Micro Fluid GmbH (shipping costs not included).
 - ▶ Please speak to your Key Account Manager for details.

In addition to the safety instructions presented in Section [For your safety](#) follow the safety instructions below.

⚠ DANGER**Danger to life from pressurized systems**

When lines and components on pressurized systems are disconnected, hydraulic fluid escapes at high pressure and penetrates deep into the body via the skin and eyes. Severe injury or death.



- ▶ Depressurize the hydraulic system including the pressure tank.
- ▶ Secure the hydraulic system against unintentional restart.
- ▶ Check components for correct assembly before pressure is applied.
- ▶ Observe maximum pressure load for fittings and lines.

⚠ CAUTION**Risk of falling from leaking hydraulic fluid**

Spilled or leaked hydraulic fluid can form a slippery film on the floor.



- ▶ Use suitable aids when filling or bleeding.
- ▶ Check all connecting elements that convey oil for leaks before switching on the motor in the parent system.
- ▶ Wipe up leaked hydraulic fluid with suitable aids.

⚠ CAUTION**Burn hazard from hot surfaces and hydraulic fluid**

A burn hazard results from directly or indirectly coming into contact with hot hydraulic fluid and hot components of the hydraulic system.



- ▶ Wear work gloves.
- ▶ Arrange the access to the hydraulic system in such a way that hot surfaces are not accessible to the user.
- ▶ Wait until the hydraulic system has cooled down before servicing or disassembling it.

Disassemble the hydraulic locking unit as follows:

1. Switch off the hydraulic locking unit via the ride control system and secure it to prevent it from being switched back on unintentionally.
2. Relieve the pressure in the piston type accumulator and connected hydraulic lines.
 - do not close the opened hydraulic lines again
 - Screw off the piston type accumulator's tapped plug (1) with a size 8 hex key.
 - slowly screw out the accessible filler screw (2) with a size 6 hex key
 - Remove check valve(s) as per the specifications on page 34
3. Drain the hydraulic fluid.
4. The hydraulic locking unit has been depressurized and can be disassembled.
5. Dispose of all hydraulic locking unit components in accordance with local regulations.

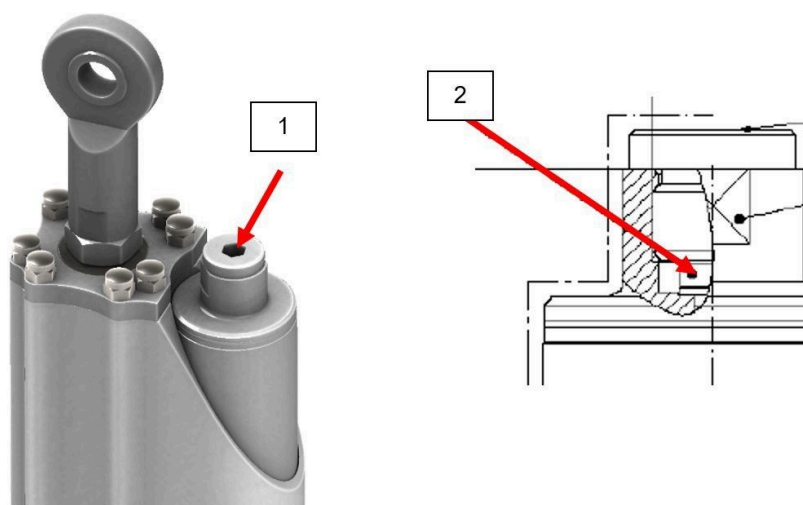
**Disposal****Dispose of hydraulic fluid and system components as follows:**

- ▶ Dispose of hydraulic fluid, packaging/containers, soaked cleaning cloths, etc., as stipulated in the specifications for hydraulic fluid according to the regional waste disposal requirements.
- ▶ Dispose of the electronic components at approved collection points or with approved disposal companies according to local regulations.
- ▶ Dispose of metal with approved specialist disposal companies.

10 Troubleshooting

WARNING

Danger of accident and death in event of improperly performed troubleshooting and fault repair

- ▶ Switch the hydraulic system off immediately if faults or damage occur.
- ▶ Evacuate rider from the affected seat.
- ▶ Secure the seat against further use.
- ▶ Observe the safety instructions.
- ▶ Only perform the actions described in the **Maintenance** chapter.

WARNING

Danger of crushing/malfunction from unexpected startup

Body parts may be crushed or shorn off if the system starts up unexpectedly.



- ▶ Wear protective clothing.
- ▶ Take precautions to prevent anyone from entering the danger zone throughout all commissioning or maintenance work.
- ▶ Do not energize solenoid valves while uninstalled.
- ▶ Do not trigger emergency release while uninstalled.

WARNING

Risk of injury in event of inadequate qualification

Improper operation of the emergency override can result in severe injury and damage to property.

- ▶ The emergency override may only be operated by trained personnel or instructed persons.
- ▶ After the emergency override has been operated, the locking, opening and holding function, as well as the drift, must be checked as per the functional check procedure.

NOTICE

Damage due to improper heating of the hydraulic locking unit

Using non-approved aids to heat the hydraulic system will damage seals and cause leaks in the hydraulic system.

- ▶ Never use heaters, gas burners or other similar heating devices to heat the system.
- ▶ Operate the hydraulic locking unit within the permissible operating temperatures.

10.1 Troubleshooting in the locking unit

The following table lists possible faults and measures to eliminate these. Contact the manufacturer in case of faults that cannot be remedied by following the descriptions here.

| Fault | Possible cause | Check | Remedy |
|--|--|--|---|
| Emergency override button sticking | Soiling | | As described in chapter Chapter 8.2.2 on cleaning. |
| Piston rod not moving (unlocking not possible) | Emergency override button faulty | Operate the emergency override and check the smooth movement of the button. | If the emergency actuation button is difficult to move, inspect as described in chapter Chapter 8.3.2 . |
| | Solenoid M1 faulty | Check resistance R; if $R \rightarrow \infty$, solenoid M1 is faulty. | Replace solenoid M1. Contact HAWE. |
| | Solenoid M2 faulty | Check resistance R; if $R \rightarrow \infty$, solenoid M2 is faulty. | Replace solenoid M2. Contact HAWE. |
| | Check valve is under heavy hydraulic load, and solenoid valve cannot switch check valve. | Operate the emergency override. If unlocking is not possible when the emergency override is operated, the restraint system must be opened as instructed in chapter Chapter 7.3.3 . When energized, valves V1, V2 or V1 and V2 cannot switch against the hydraulic pressure and the hydraulic locking unit remains locked. | Locking unit must be replaced. Contact HAWE. Operate both valves and simultaneously move the piston rod in the locked direction. |
| Piston rod only extends or retracts when emergency override operated (unlocking only possible when emergency override is operated) | Solenoid M1 faulty | Check resistance R; if $R \rightarrow \infty$, solenoid M1 is faulty. | Replace solenoid M1. |
| | Solenoid M2 faulty | Check resistance R; if $R \rightarrow \infty$, solenoid M2 is faulty. | Replace solenoid M2. |
| Piston rod does not extend fully (restraint system does not open enough) | Internal leakage | n.a. | Locking unit must be replaced. Contact HAWE. |
| | Nitrogen pressure loss in piston type accumulator | Top up according to the data sheet specifications using the HAWE filling set (see accessories on the technical data sheet). | As described in Chapter 8.5 |
| Piston rod not holding locking position (lock faulty) | Internal leakage | n.a. | Locking unit must be replaced. Contact HAWE. |

| Fault | Possible cause | Check | Remedy |
|--|--|--|---|
| Piston rod can be moved 2 to 10 mm in locking direction at 20°C. (Locking is delayed after closing the restraint system.) | Piston rod extension speed exceeded (temporary slack). | Check restraint system closing speed and compare against technical data specifications. | Reduce restraint system closing speed. |
| | Not enough hydraulic fluid is flowing from the accumulator into the locking unit because the ambient temperature is too low (temporary slack). | Check ambient temperature and operating temperature of hydraulic system and compare against technical data specifications. | Locking unit must be operated within the specifications. (Unit must be adjusted if operating temperature changes permanently. Contact HAWE.) |
| | Piston rod can be moved permanently in locking direction (permanent slack). | Permanently trapped air in locking unit. | Locking unit must be replaced. Contact HAWE. |

11 Appendix

Further documentation, such as technical data sheets, circuit diagrams and installation drawings are part of the technical documents and are delivered separately.

The attached product information from third-party manufacturers is not necessarily the most current version. To obtain the latest product information, contact the respective manufacturer.

Optional documents

- TÜV certificate
- Declaration of compliance with the order 2.1 according to DIN EN 10204
- Test report 2.2 according to DIN EN 10204

11.1 Technical data

 Maximum loads in drawings and product documentation are calculated according to DIN EN 13814. For locking units on seat classes* 4 and 5 a 70/30 load distribution was applied, and for locking units on seat class* 3 a direct load of 100%. The loads relate to the linear forces acting directly on the piston rod of the hydraulic locking unit.

If the restraint system is not safeguarded by redundancy, the maximum permissible holding forces must be recalculated. Get in touch with HAWE Micro Fluid GmbH.

* Seat classes defined in DIN EN 13814

You will be provided with the hydraulic and electrical data of the individual product variants as accompanying external documentation with the product-specific technical data sheet.

11.1.1 Operating conditions

| | |
|--|---|
| permissible ambient temperature (operation) | -10°C to +60°C |
| permissible ambient temperature (transport and storage) | -10°C to +60°C |
| Service life | Maximum 10 years or 1 million cycles (depending on which comes first, starting with the date of delivery) |
| Warranty | 2 years |
| Shutdown/storage time | 6 months (Longer downtimes will increase the risk of seals degrading.) |
| Installation position | Any, taking into account the tilt angle |
| Noise emission (emission sound pressure level of HLU) | < 72 dB(A) |
| Hydraulic fluid | AVIA FLUID RSL 22 |

11.1.2 Weights and measures

i The shipping designation and data given under the UN numbers are basic descriptions. There are variations between national governments (such as emergency numbers for the USA) and individual airlines.

Note the following exceptions: IMDG code (Chapter 2.2 in 2.2.2.5 Class 2.2) IATA/DGR (Section 3 in 3.2.2.4 Division 2.2), exemption in ADR regulations (in 1.1.3.2).

Note: The Material Safety Data Sheet (MSDS) is available on request.

| In operation | |
|---------------------------------|-----------------------------------|
| Weight | As per technical data sheet |
| Installation dimensions (WxHxD) | As per technical data sheet |
| In transportation | |
| Transport dimensions | As per technical data sheet |
| Transport weight | As per delivery note/packing list |

11.2 Shipping data

| Shipping | |
|---|--|
| Correct technical name Shipping designation for national and international road and rail transport, international maritime transport, and transport by inland waterway | GEGENSTÄNDE UNTER PNEUMATISCHEN DRUCK, ARTICLES, PRESSURIZED, PNEUMATIC (containing non-flammable gas) |
| Correct technical name Shipping name for air transport | ARTICLES, PRESSURIZED, PNEUMATIC (containing non-flammable gas) |
| UN number for national and international road and rail transport, and transport by inland waterway | UN 3164 Nicht beschränkt auf Grund der Bestimmung des Europäischen Übereinkommen über die internationale Beförderung gefährlicher Güter auf der Straße (ADR): SV283, SV594. Not restricted as per special provision ADR: SV283, SV594. |
| UN number for international maritime transport | UN 3164 Nicht beschränkt auf Grund der Bestimmung des International Maritime Dangerous Goods Code (IMDG): SV283. Not restricted as per special provision IMDG-Code: SV283. |
| UN number for air transport | UN 3164 Nicht beschränkt auf Grund Bestimmung der International Air Transport Association Dangerous Goods Regulations (IATA-DGR): A114. Not restricted as per special provision IATA-DGR: A114. |
| Class | None |

| Shipping | |
|-------------------------|------|
| Danger label number | None |
| Packaging group | None |
| Packaging specification | None |

11.3 System - parts list

Only use genuine HAWE spare parts. For detailed ordering instructions refer to the accompanying external documentation, the technical data sheet.

Contact details

Headquarters

HAWE Hydraulik SE
Einsteinring 17
85605 Aschheim
Germany
Email: info@hawe.de
www.hawe.com
Phone: +49 (0) 89 / 37 91 00 - 1000

Manufacturer

HAWE Micro Fluid GmbH
Borsigstraße 11
93092 Barbing
Germany
e-mail: info@hawe-microfluid.com
www.hawe.com
Phone: +49 (0) 89 / 37 91 00 - 6000

Further information

HAWE Hydraulik SE is a responsible development partner with application expertise and experience in more than 70 areas of mechanical and plant engineering. The product range includes hydraulic power packs, constant and variable pumps, valves, sensors and accessories. Electronic components, ideally matched to hydraulic components, complement modular systems and facilitate control, signal evaluation and error detection. The intelligent system solutions reduce energy consumption and operating costs. Compact drives save space and permit innovative machine design.

The company is certified to ISO 9001, ISO 14001, ISO 45001, ISO 50001.



■ HAWE subsidiaries and service repair shops

- Germany
- Denmark
- Austria
- Switzerland
- Italy
- France
- Spain

● HAWE sales partners

- Finland
- Sweden
- Slovenia
- Russia
- Canada
- USA
- Brazil
- China
- India
- Japan
- Korea
- Singapore
- Taiwan
- Australia

You can find further information on HAWE Hydraulik, your local contact and the range of hydraulics training sessions offered at: www.hawe.com.

